

KL[®] megl



GLASBAUBESCHLÄGE

für Duschen & Innentüren

GLASS HARDWARE
for showers & interior doors



MIT TRADITION, HANDWERK & LEIDENSCHAFT

Unsere Beschläge fertigen wir in der Regel aus hochwertigem und solidem Messing, in Sonderheit die für den Sanitärbereich. Messing ist ein sehr langlebiges und vielseitiges Material, mit einigen entscheidenden Vorteilen:

- **Sicherheit.** Messing ist nicht nur stabil, sondern hat gleichzeitig eine gewisse Flexibilität. Schon die alten Seefahrer wussten nicht nur die Druck, sondern auch die Schlagfestigkeit zu schätzen: große Vorteile gegenüber spröderen Metallen.
- **Oberflächen.** Neben den sehr guten Werten bei der Korrosions beständigkeit lässt sich Messing hervorragend polieren und besonders mit galvanischen Oberflächen veredeln, z.B. mit Chrom. Messing wird dementsprechend vielfältig in der Sanitärindustrie als Basismaterial für Armaturen genutzt.
- **Sonderlösungen.** Messing lässt sich mit der richtigen Manufakturereinrichtung gut zerspanen und bearbeiten und bietet gleichzeitig beste Voraussetzungen für verschiedenste Oberflächen.

Nicht nur bei der Auswahl der Materialien setzen wir auf Hochwertigkeit. Bis heute steht Handarbeit als Garant für gute Qualität – und das zu Recht. Unsere Produkte werden fast ausschließlich in unserer Manufaktur in Waldbröl händisch gefertigt. Materialauswahl und Fertigung vor Ort dienen auch der Nachhaltigkeit, ein wesentliches Ziel unseres Unternehmens.

Unser Team, bestehend u.a. aus Ingenieuren, Meistern und Glastechnikern, arbeitet stets daran, unsere Produkte in Funktionalität und Design zu perfektionieren. Auch bei der Fertigung von Sonderlösungen oder der Planung komplexer Projekte sind wir gerne Ihr Ansprechpartner und unterstützen Sie bei Ihrem Bauvorhaben.

WITH TRADITION, PASSION & CRAFTSMANSHIP

We usually manufacture our fittings from high-quality and solid brass, at least those for use in the sanitary area.

Brass is a very durable and versatile material, with some key advantages:

- **Security.** Brass is not only stable, but also has a certain flexibility. Even the old time sailors appreciated not only the pressure- but also the impact resistance: great advantages over more rough metals.
- **Finishes.** In addition to the very good attributes for corrosion resistance, brass can be polished excellently and especially refined with plating finishes, e.g. with chrome. Accordingly, brass is widely used in the sanitary industry as a base material for fittings.
- **Custom Manufacturing.** Brass can be easily machined and processed with the right manufacturing equipment and at the same time offers the best conditions for a wide variety of finishes.

We do not only focus on high quality when selecting the materials. To this day, manual work is a guarantee of good quality – and rightly so. Our products are almost exclusively made by hand in our factory in Waldbroel, Germany. Material selection and on-site production also serve sustainability, a key goal of our company.

Our team, consisting of engineers, masters and glass technicians, is always working to perfect our products in terms of functionality and design. We are also happy to be your contact for the production of special solutions or the planning of complex projects and support you with our expertise.

WICHTIGE HINWEISE IMPORTANT INFORMATION

Fertigungstechnische Toleranzen und Änderungen sind uns vorbehalten. Alle Angaben ohne Gewähr.

We explicitly reserve the right of production tolerances and changes in our products.

KL megla Germany GmbH ist alleiniger Inhaber der eingetragenen Wortmarke "KL megla". Sämtliche Inhalte dieser Publikation sind geistiges Eigentum der KL megla Germany GmbH und als solche urheberrechtlich geschützt. Die Veröffentlichung, Bearbeitung, Verbreitung und jede Art der Verwertung außerhalb der Grenzen des Urheberrechtes bedürfen der schriftlichen Zustimmung der KL megla Germany GmbH, Waldbröl Deutschland. © KL megla Germany GmbH

KL megla Germany GmbH is the sole owner of the registered word mark "KL megla". All contents of this publication are the intellectual property of KL megla Germany GmbH and as such are protected by copyright. Duplication, processing, distribution and any kind of exploitation outside the limits of copyright law require the written consent of KL megla Germany GmbH, Waldbröl Germany. © KL megla Germany GmbH



5 JAHRE GARANTIE

5 YEAR WARRANTY

MADE IN GERMANY



5 JAHRE HERSTELLERGARANTIE AUF FOLGENDE PRODUKTE:

5 YEAR MANUFACTURER WARRANTY FOR THE FOLLOWING PRODUCTS:

Wellness, Wellness Premium, Wellness HS, Wellness HS CL, Fit, Next HS, Next HS CL, Milano Original Premium, Milano Original, Milano, Milano Pur, Chalet AT, Chalet PT, Stratego, Filigrano, Türgriffe Door Handles

CLASSTEC®

2 JAHRE GARANTIE

2 YEAR WARRANTY











2 JAHRE HERSTELLERGARANTIE AUF FOLGENDE PRODUKTE:
2 YEAR MANUFACTURER WARRANTY FOR THE FOLLOWING PRODUCTS:

CLASSTEC® Bella, CLASSTEC® Vital

ÜBERSICHT

OVERVIEW







- Entspricht der Spezifikation
Corresponds to the specifications
- Oder nach innen öffnend
Or inwards opening

								
	Wellness	Wellness Premium	Wellness HS	WellnessHS CL	CLASSTEC® Bella	Milano	Milano Pur	Milano Original
Anschlagtürsystem Opening outwards	■	■	■	●	●			
Pendeltürsystem Opening inwards and outwards						●	●	●
Hebe-Senk Mechanismus Gravity based lifting mechanism			●	●				
Flächenbündige Verschraubung Countersunk screws				●				
Für Rundduschen geeignet Suitable for round shower enclosures	●	●	●					
Ideal für Faltlösungen Ideal for folding solutions	●	●	●	●	●			
Badewannenaufsätze Bathtub glass screen	●	●	●	●	●			
Saunavarianten erhältlich Sauna type hinges available								●
Für Duschtürsysteme konzipiert Designed for Shower Door Systems	●	●	●	●	●	●	●	●
Nulllage stufenlos einstellbar Adjustable index position		●	●	●		●	●	●
Durchgehende Dichtung (By-Pass-System) Continuous seal (By-Pass-System)	●	●	●	●	●			
Selbstschließend, Softclose Self-closing, Softclose								
Vollabgedeckte Verschraubung Covered backplate, no visible screws			●		●			●
Wandanschraubplatte mit Langloch Wallbracket with slotted hole		●	●	●	●	●	●	
In das Band integrierte Dichtung Integrated seal in hinge								
Standard Glasstärke(n) in mm Standard glass thickness(es) in mm	8	8	8	8	8	8 & 10	8 & 10	8 & 10
Max. Türgröße in mm Max door size in mm	1000 x 2250	1000 x 2250	900 x 2250	900 x 2250	1000 x 2250	1000 x 2250	1000 x 2250	1000 x 2250
Max. Türgewicht Max door weight	40 kg	40 kg	35 kg	35 kg	40 kg	40 kg	40 kg	50 kg

ÜBERSICHT

OVERVIEW

- Entspricht der Spezifikation
Corresponds to the specifications
- Oder nach innen öffnend
Or inwards opening

	 Milano Original Premium	 Next HS	 Next HS CL	 CLASSTEC® Vital	 Chalet AT	 Chalet PT
Anschlagtürsystem Opening outwards					●	
Pendeltürsystem Opening inwards and outwards	●	●	●	●		●
Hebe-Senk Mechanismus Gravity based lifting mechanism		● +/- 5 mm	● +/- 5 mm			
Flächenbündige Verschraubung Countersunk screws			●			
Für Rurnduschen geeignet Suitable for round shower enclosures						
Ideal für Faltlösungen Ideal for folding solutions						
Badewannenaufsätze Bathtub glass screen						
Saunavarianten erhältlich Sauna type hinges available					●	
Für Duschtürsysteme konzipiert Designed for Shower Door Systems	●	●	●	●	○ optional	
Nulllage stufenlos einstellbar Adjustable index position	● 3-Punkt 3-Point	●	●	●		● +/- 2,5°
Durchgehende Dichtung (By-Pass-System) Continuous seal (By-Pass-System)						
Selbstschließend, Softclose Self-closing, Softclose					●	●
Vollabgedeckte Verschraubung Covered backplate, no visible screws	●	●			●	
Wandanschraubplatte mit Langloch Wallbracket with slotted hole	●	●	●			
In das Band integrierte Dichtung Integrated seal in hinge		●	●			
Standard Glasstärke(n) in mm Standard glass thickness(es) in mm	8 & 10	8 & 10	8 & 10	8	8	10
Max. Türgröße in mm Max door size in mm	1100 x 2250	1000 x 2250	1000 x 2250	1000 x 2000	1000 x 2100	1000 x 2500
Max. Türgewicht Max door weight	50 kg	40 kg	40 kg	40 kg	45 kg	65 kg

MILANO ORIGINAL PREMIUM



EIGENSCHAFTEN
FEATURES

MAX. TÜRMASSE
MAX. DOOR DIMENSIONS
1.100 x 2.250 mm

GLAS (ESG)
GLASS (TSG)
8 & 10 mm

TÜRGEWICHT
DOOR WEIGHT
50 kg

OBERFLÄCHEN
FINISHES

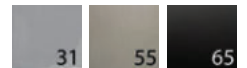

Sonderoberflächen möglich
other finishes on request

PENDELTÜRSYSTEM
DOUBLE ACTION DOOR SYSTEM

FUNKTIONEN
FEATURES

Einstellbare Nulllage
3-Punkt-Nulllage
geschlossene Bandrolle
Vollabgedeckte Verschraubung

Adjustable index position
3-Point index position
hidden index cylinder
Covered screws

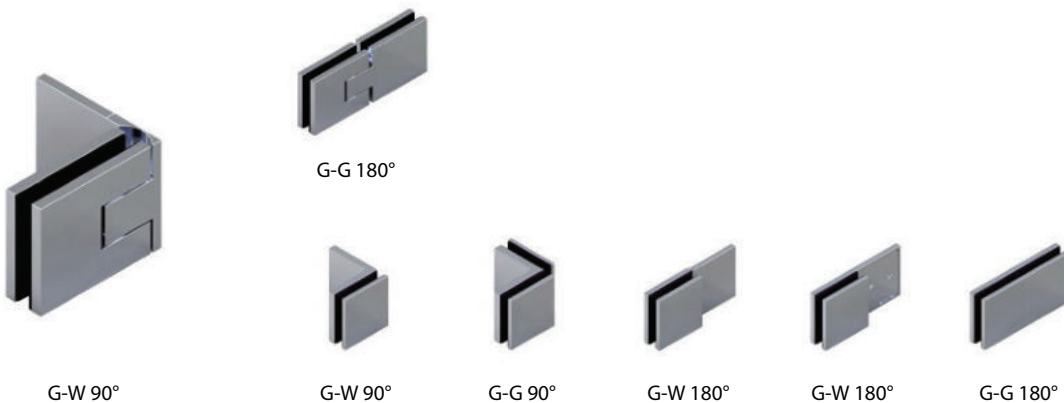





BRÄSSWORKS
individual hardware for glass

MOTIVA

CNC Gravuren & Sonderoberflächen
CNC engraving & Custom Finishes



STANDARD OBERFLÄCHEN

STANDARD FINISHES

Weitere Oberflächen finden Sie in unserer Preisliste | More finishes can be found in our price list

10	Silberfarbig eloxiert	Silver color anodized
31	Glanzverchromt	Bright chrome
46	Mattverchromt	Satin chrome
55	Nickel gebürstet (Edelstahloptik)	Brushed nickel (stainless steel look)
65	ONYX schwarz	ONYX black
91	Edelstahl gebürstet	Brushed stainless steel

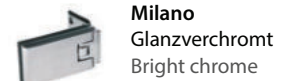

Milano
Glanzverchromt
Bright chrome



Chalet AT
Nickel gebürstet
Brushed nickel



Milano Original
ONYX schwarz
ONYX black

SONDER OBERFLÄCHEN

SPECIAL FINISHES

36	Glanzvernickelt	Bright nickel
51	Mattvernickelt	Satin nickel
59	Messing Braun	Brown brass
61	Feingold	Fine gold
62	Gelbgold (Farbton ähnlich wie Messing)	Yellow gold (brass color)
63	Altkupfer gebürstet mit Klarlack	Brushed old copper with clear varnish ^o
64	Altbronze bebürstet mit Klarlack	Brushed old bronze with clear varnish ^o
67	Matt vergoldet	Satin gold plated
68	Vergoldet mit Roségold	Rosé gold plated ^o
69	Messing gebürstet mit Klarlack	Brushed brass with clear varnish ^o
81	RAL 9005 schwarz matt pulverbeschichtet	RAL 9005 matt black powder coated ^{A)}
82	RAL 9010 weiß matt pulverbeschichtet	RAL 9010 white matt powder coated ^{A)}
84	RAL 9005 schwarz glänzend pulverbeschichtet	RAL 9005 glossy black powder coated ^{A)}



Milano
Gelbgold
Yellow gold



Wellness HS
Altkupfer gebürstet
Brushed old copper



Chalet PT
Altbronze gebürstet
Brushed old bronze



05003 Griff // Handle
Vergoldet mit Roségold
Rosé gold plated

