

Handläufe und Zubehör

handrails and accessories

- für Glasstärke von 17,52 bis 25,52 mm
 - in Edelstahl A2 und A4
 - viele verschiedene Anschlussvarianten
- for glass thickness from 17.52 to 25.52 mm
 - in stainless steel 304 and 316
 - many different connection types



Edelstahl (A2/A4) | stainless steel (304/316)

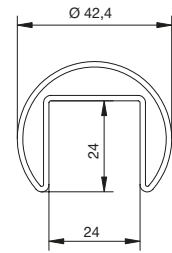

Runder Handlauf/Nutrohr | round handrail/slotted tube

Oberfläche: geschliffen
surface: brushed

Art.-Nr. art.-no.	Material material	Für Rohr Ø For tube Ø		Länge length	Oberfläche surface
10242642A2	A2 304	42,4 x 2,0	1,5	2500	Korn grain 240
10242542A2	A2 304	42,4 x 2,0	1,5	5000	Korn grain 240

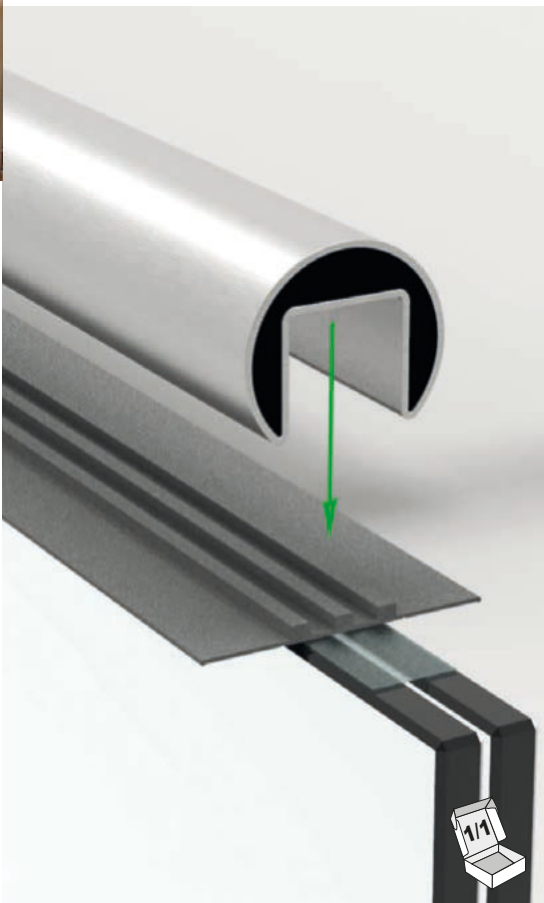

Edelstahl (A2/A4) | stainless steel (304/316)

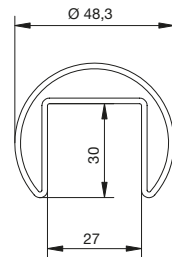

Runder Handlauf/Nutrohr | round handrail/slotted tube

Oberfläche: geschliffen
surface: brushed

Art.-Nr. art.-no.	Material material	Für Rohr Ø For tube Ø		Länge length	Oberfläche surface
10242648A2	A2 304	48,3	1,5	2500	Korn grain 240
10242548A2	A2 304	48,3	1,5	5000	Korn grain 240
10242548A4	A4 316	48,3	1,5	5000	Korn grain 240

Artikel nicht mehr im Sortiment

bearbeitet GuB 18.09.2024



Edelstahl (A4) | stainless steel (316)

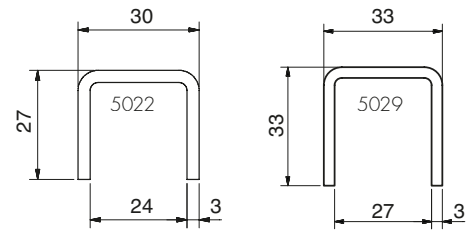

Handlauf | handrail

Oberfläche: geschliffen
surface: brushed

Art.-Nr. art.-no.	Material material		Länge length	Oberfläche surface
5022VA4-2500	A4 316	17,52/21,52	2500	Korn grain 320
5022VA4-5M	A4 316	17,52/21,52	5000	Korn grain 320
5029VA4-2500	A4 316	25,52	2500	Korn grain 320
5029VA4-5M	A4 316	25,52	5000	Korn grain 320

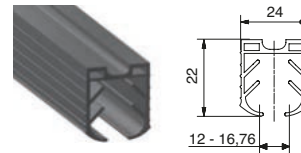
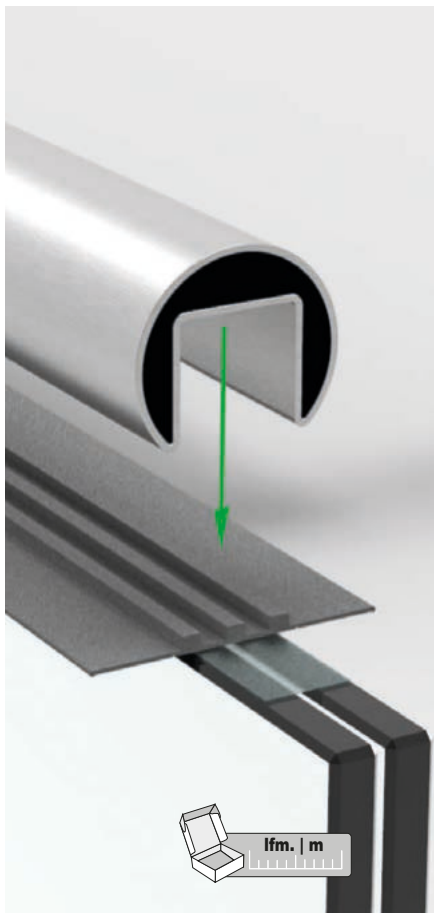

10214642KU
passend für Handlauf Ø 42,4 mm
und u-Profil 5022VA4
suitable for handrail Ø 42,4 mm
and u-profile 5022VA4

für Glasdicke 17,52 mm | for glass thickness 17,52 mm

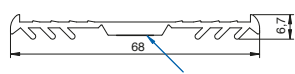

Klebeband selbstklebend
Self-adhesive tape

für Glasdicke 21,52 mm | for glass thickness 21,52 mm

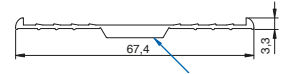

Klebeband selbstklebend
Self-adhesive tape

10214742KU / 10214842KU
passend für Handlauf Ø 42,4 mm
und u-Profil 5022VA4
suitable for handrail Ø 42,4 mm
and u-profile 5022VA4

für Glasdicke 25,52 mm | for glass thickness 17,52 mm

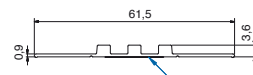

Klebeband selbstklebend
Self-adhesive tape

10245448KU
passend für Handlauf Ø 48,3 mm
und u-Profil 5029VA4-5M
suitable for handrail Ø 48,3 mm
and u-profile 5029VA4-5M

Elastomer für Handlauf | elastomer profile for handrail

Art.-Nr. art.-no.	Material material	Länge length	
10214642KU	Elastomer	lfm. m	12 - 16,76
10214742KU	Elastomer	lfm. m	17,52
10214842KU	Elastomer	lfm. m	21,52
10245448KU	Elastomer	lfm. m	25,52



Edelstahl (A4) | stainless steel (316)

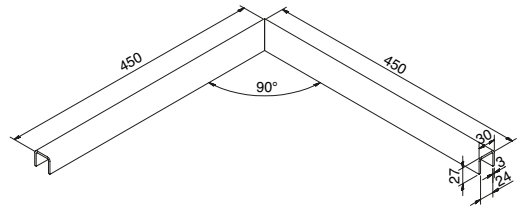

Ecke verschweißt, zu Kantenschutzprofil | corner welded, for edge protection profiles

Oberfläche: geschliffen
surface: brushed

Art.-Nr. art.-no.	Material material		Oberfläche surface
5022VA4-90H	A4 316	17,52/21,52	Korn grain 320



Edelstahl (A4) | stainless steel (316)

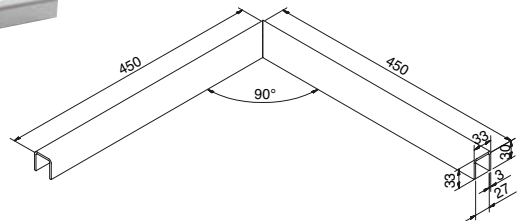

Ecke verschweißt, zu Kantenschutzprofil | corner welded, for edge protection profiles

Oberfläche: geschliffen
surface: brushed

Art.-Nr. art.-no.	Material material		Oberfläche surface
5029VA4-90H	A4 316	25,52	Korn grain 320



Holz | Wood



10242942BU

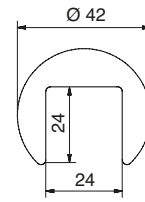

Holz-Handlauf (weitere Holzarten auf Anfrage)

wooden handrail (additional types of wood upon request)

Genutet 24 mm | Slotted 24 mm

Art.-Nr. art.-no.	Material material	Ø	Länge length
10242942BU	Gedämpfte Rotbuche damped copper beech	42,4	2500
10242942EI	Eiche Oak	42,4	2500

nicht lastabtragend | non load bearing

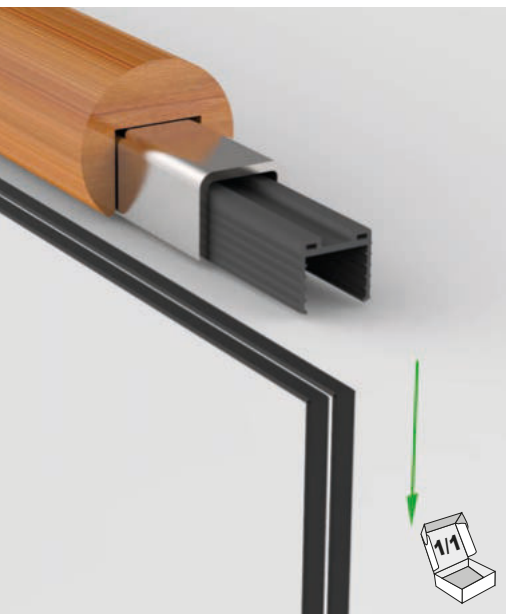

Holz | Wood



10242855EI

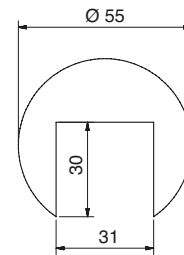

Holz-Handlauf (weitere Holzarten auf Anfrage)

wooden handrail (additional types of wood upon request)

Genutet 30 mm für Kantenschutz | Slotted 30 mm for edge protection

Art.-Nr. art.-no.	Material material	Ø	Länge length
10242855BU	Gedämpfte Rotbuche damped copper beech	55	2500
10242855EI	Eiche Oak	55	2500



10213842A2



10213742A2



10240642A2



Edelstahl (A2/A4) | stainless steel (304/316)

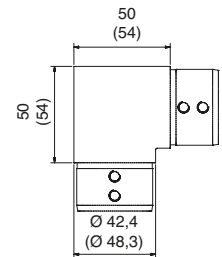
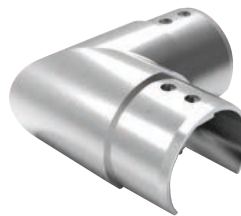

Rohrverbinder | tube connector

Oberfläche geschliffen, für Nutrohr (90° waagrecht)
brushed surface, for slotted tube (90° horizontal)

Art.-Nr. art.-no.	Material material		für Handlauf Ø for handrail Ø	Oberfläche surface
10213842A2	A2 304	1,5	42,4	Korn grain 240
10213848A2	A2 304	1,5	48,3	Korn grain 240
10213848A4	A4 316	1,5	48,3	Korn grain 240

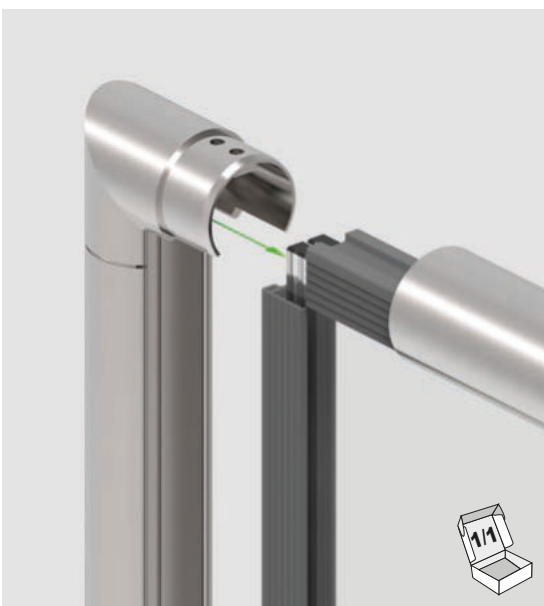

Edelstahl (A2/A4) | stainless steel (304/316)

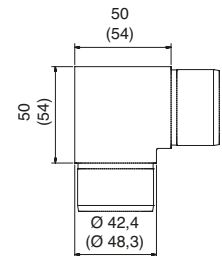

Rohrverbinder | tube connector

Oberfläche geschliffen, für Nutrohr (90° senkrecht)
brushed surface, for slotted tube (90° vertical)

Art.-Nr. art.-no.	Material material		Für Handlauf Ø for handrail Ø	Oberfläche surface
10213742A2	A2 304	1,5	42,4	Korn grain 240
10213742A4	A4 316	1,5	42,4	Korn grain 240
10213748A2	A2 304	1,5	48,3	Korn grain 240
10213748A4	A4 316	1,5	48,3	Korn grain 240



Edelstahl (A2/A4) | stainless steel (304/316)

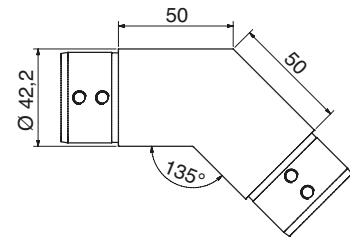

Rohrverbinder | tube connector

Oberfläche geschliffen, für Nutrohr (135° waagrecht), starr
brushed surface, for slotted tube (135° horizontal), fixed

Art.-Nr. art.-no.	Material material		Für Handlauf Ø for handrail Ø	Oberfläche surface
10240642A2	A2 304	1,5	42,4	Korn grain 240
10240642A4	A4 316	1,5	42,4	Korn grain 240



Edelstahl (A2/A4) | stainless steel (304/316)

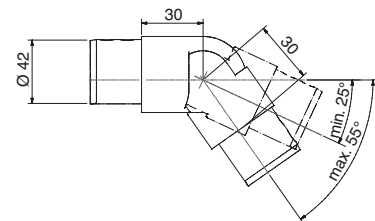

Rohrverbinder | tube connector

Oberfläche geschliffen, für Nutrohr, beweglich
brushed surface, for slotted tube, flexible

Art.-Nr. art.-no.	Material material		Für Handlauf Ø for handrail Ø	Oberfläche surface
10240842A2	A2 304	1,5	42,4	Korn grain 240
10240842A4	A4 316	1,5	42,4	Korn grain 240



Edelstahl (A2/A4) | stainless steel (304/316)

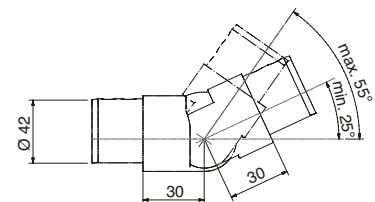

Rohrverbinder | tube connector

Oberfläche geschliffen, für Nutrohr, beweglich
brushed surface, for slotted tube, flexible

Art.-Nr. art.-no.	Material material		Für Handlauf Ø for handrail Ø	Oberfläche surface
10240742A2	A2 304	1,5	42,4	Korn grain 240
10240742A4	A4 316	1,5	42,4	Korn grain 240



10242742A2



10233842A2



10214042A2



Edelstahl (A2/A4) | stainless steel (304/316)

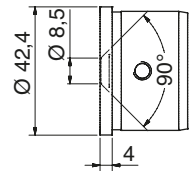

Wandanschluss | Wall connection

Oberfläche geschliffen, für Nutrohr
brushed surface, for slotted tube

Art.-Nr. art.-no.	Material material		Für Handlauf Ø for handrail Ø	Oberfläche surface
10233842A2	A2 304	1,5	42,4	Korn grain 240
10233842A4	A4 316	1,5	42,4	Korn grain 240



Edelstahl (A2/A4) | stainless steel (304/316)

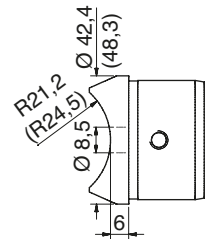

Rohranschluss | Tube connection

Oberfläche geschliffen, für Nutrohr
brushed surface, for slotted tube

Art.-Nr. art.-no.	Material material		Für Handlauf Ø for handrail Ø	Oberfläche surface
10213942A2	A2 304	1,5	42,4	Korn grain 240
10213942A4	A4 316	1,5	42,4	Korn grain 240
10213948A2	A2 304	1,5	48,3	Korn grain 240
10213948A4	A4 316	1,5	48,3	Korn grain 240

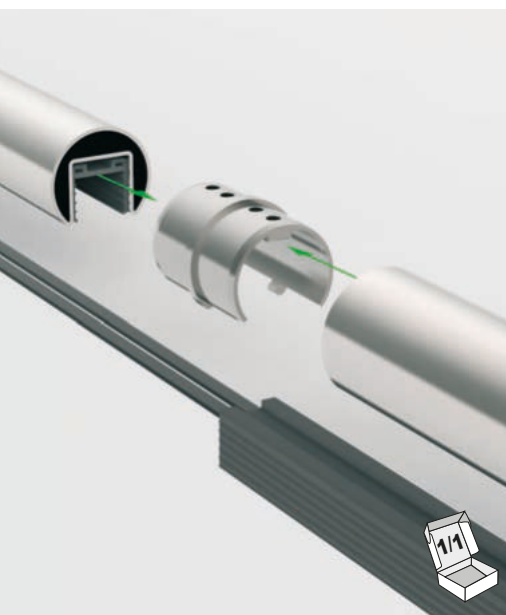

Edelstahl (A2/A4) | stainless steel (304/316)

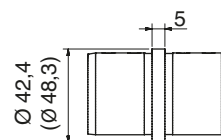

Rohrverbinder | tube connector

Oberfläche geschliffen, für Nutrohr (180° waagrecht)
brushed surface, for slotted tube (180° horizontal)

Art.-Nr. art.-no.	Material material		Für Handlauf Ø for handrail Ø	Oberfläche surface
10214042A2	A2 304	1,5	42,4	Korn grain 240
10214042A4	A4 316	1,5	42,4	Korn grain 240
10214048A2	A2 304	1,5	48,3	Korn grain 240
10214048A4	A4 316	1,5	48,3	Korn grain 240

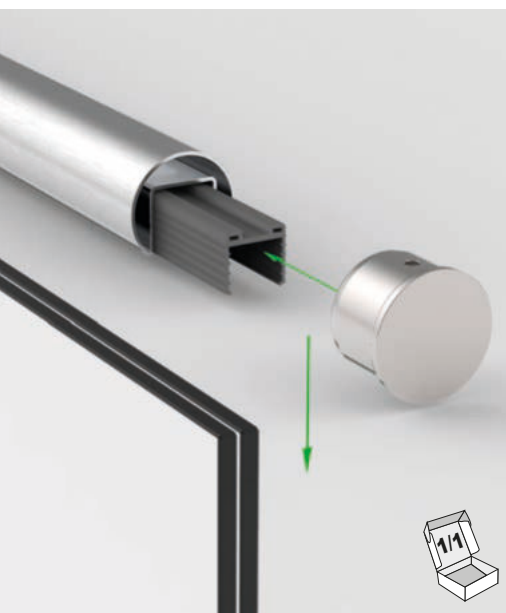

Edelstahl (A2/A4) | stainless steel (304/316)

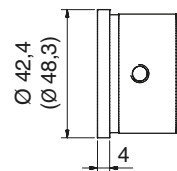

Endkappe | end cap

Oberfläche geschliffen, für Nutrohr
brushed surface, for slotted tube

Art.-Nr. art.-no.	Material material		Für Handlauf Ø for handrail Ø	Oberfläche surface
10214142A2	A2 304	1,5	42,4	Korn grain 240
10214148A2	A2 304	1,5	48,3	Korn grain 240
10214148A4	A4 316	1,5	48,3	Korn grain 240



Edelstahl (A2/A4) | stainless steel (304/316)

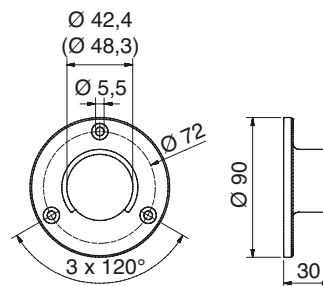

Wandflansch | wall flange

Oberfläche geschliffen, für Nutrohr
brushed surface, for slotted tube

Art.-Nr. art.-no.	Material material		Für Handlauf Ø for handrail Ø	Oberfläche surface
10242742A2	A2 304	1,5	42,4	Korn grain 240
10242748A2	A2 304	1,5	48,3	Korn grain 240
10242748A4	A4 316	1,5	48,3	Korn grain 240



Edelstahl (A2) | stainless steel (304)

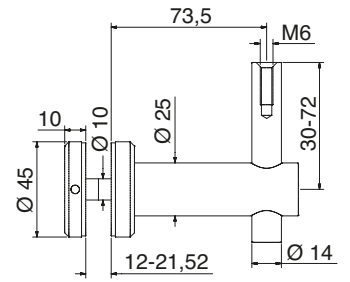

Handlaufträger | handrail support

Oberfläche geschliffen, höhenverstellbar mit Glasanschluss
brushed surface, height-adjustable with glass connector

Art.-Nr. art.-no.	Material material	Glasbohrung glass hole		Oberfläche surface
10238044A2	A2 304	Ø 16	12 - 21,52	Korn grain 240



Edelstahl (A2) | stainless steel (304)

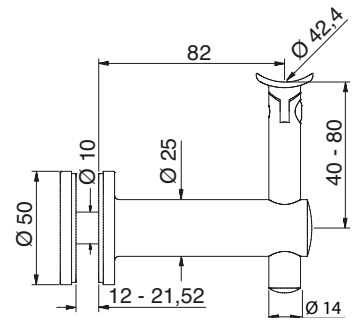

Variabler Handlaufträger | flexible handrail support

Oberfläche geschliffen, höhenverstellbar mit Glasanschluss
brushed surface, height-adjustable with glass connector

Art.-Nr. art.-no.	Material material	Glasbohrung glass hole		Oberfläche surface
10241042A2	A2 304	Ø 16	12 - 21,52	Korn grain 240