



D

PROGRAMM

Ab 2023



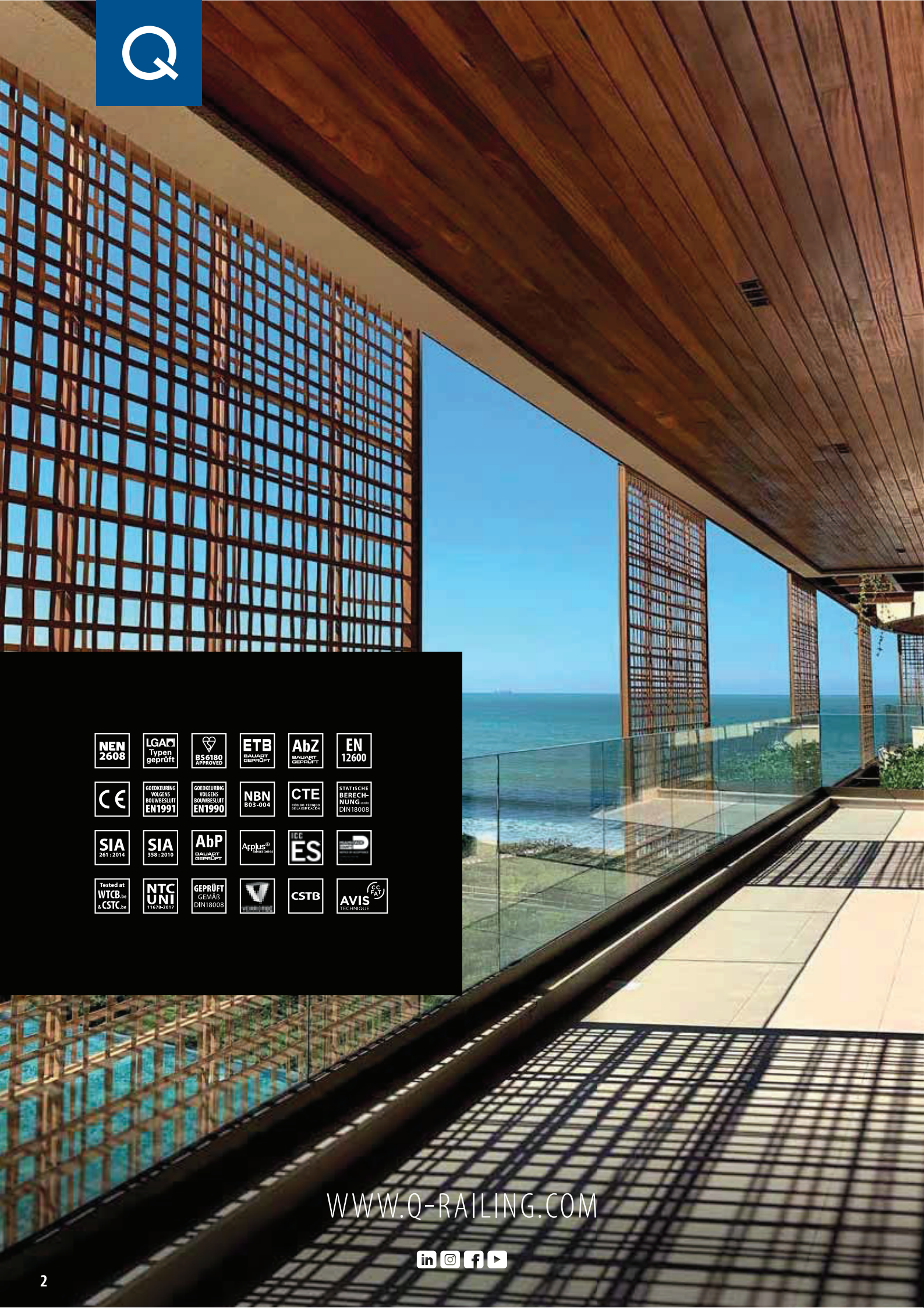

- NEN 2608
- LGAD Typen geprüft
- BS 6180 APPROVED
- ETB BALAJART GEPRÜFT
- AbZ BALAJART GEPRÜFT
- EN 12600
- CE
- GOEDKEURING VOLGENS BOUWBESLUIT EN1991
- GOEDKEURING VOLGENS BOUWBESLUIT EN1990
- NBN B03-004
- CTE Central Techniek Centrum Nederland
- STATISCHE BERECHNINGEN DIN18008
- SIA 261 : 2014
- SIA 358 : 2010
- AbP BALAJART GEPRÜFT
- Appplus[®] laboratoires
- ICC ES
- D
- Tested at WTCB^{br} & CSTC^{br}
- NTC UNI 11678-2017
- GEPRÜFT GEMÄß DIN18008
- V
- CSTB
- AVIS[®] CC FAI[®] TECHNIQUE

WWW.Q-RAILING.COM



WILLKOMMEN BEI DER PREMIUM MARKE FÜR GELÄNDERSYSTEME

Was bedeutet Premium für uns? Es bedeutet, dass wir nicht ruhen, bis wir die Perfektion erreicht haben, die Sie erwarten.

PREMIUM IN JEDER HINSICHT

Nur das Beste

- Gleichbleibende Qualität
- Hochwertige Materialien
- Makellose Oberflächen
- Extrem präzise Maße und minimale Toleranzen

Erstaunlich schnell

- Alles sofort ab Lager lieferbar
- Schnelle Lieferung
- Fundierte technische Beratung
- Rund um die Uhr im Onlineshop bestellen

Unbegrenzte Möglichkeiten

- Unzählige Produkte
- Zahlreiche Designvarianten
- Hier finden Sie alles, um ein komplettes Geländer oder Handläufe zu kreieren
- Kombinieren Sie die Komponenten nach Belieben und schaffen Sie einen individuellen Look

100% sicher

- Ausgiebige Tests im unternehmenseigenen Prüflabor
- Umfangreiche Prüfungen durch unabhängige, zertifizierte Prüfstellen und führende Behörden
- Testverfahren und behördliche Genehmigungen entsprechend der internationalen Bauvorschriften und Normen

Ästhetik und Raffinesse

- Regelmäßige Produktinnovationen und Produktoptimierungen
- Vortreffliches Design
- Ausgeklügelte Details, die eine schnelle und einfache Montage ermöglichen

Onlineangebot : www.q-railing.com

- Montagevideos, BIM-Objekte, CAD-Zeichnungen und weitere technische Dokumente und Ausschreibungstexte
- Q-PAC (Professional Anchor Calculation) Software, mit der Sie genau den richtigen Q-railing Anker finden, den Sie benötigen
- Kataloge, Broschüren, Referenzprojekte und vieles mehr



Beanspruchung: Leicht und mittel
Verwendung: Innen- und Außenbereich
Montage: Boden-, In-Boden- und Seitenmontage
Anwendung: Balkone, Galerien, Wege, Abtrennungen, Treppen und französische Balkone
Material: Aluminium (gebürstet anodisiert, roh und pulverbeschichtet in RAL 9005 schwarz)
Glasstärke: 12 bis 21,52 mm

Finden Sie alle Informationen zu Easy Glass Smart online:

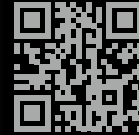

<https://q-ne.ws/Smart23>

EASY GLASS® SMART



red dot winner 2020
innovative product

Unschlagbar einfache Installation

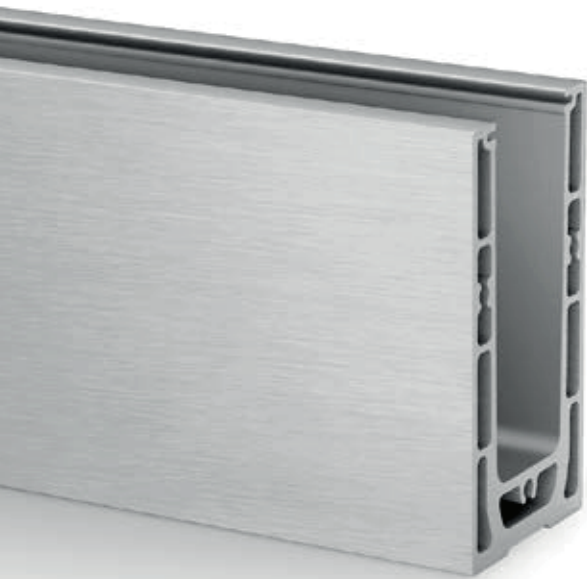

Easy Glass® Smart beinhaltet das revolutionäre Q-disc® System. Die Kombination aus Inlay und Q-disc ermöglicht eine extrem schnelle Glasmontage. Installieren Sie das Bodenprofil, positionieren Sie das Glas und fixieren Sie anschließend mit nur einer einzigen Handbewegung jede Scheibe sicher im Profil. Mit der justierbaren Variante des Q-disc Systems können Sie zudem jede einzelne Glasscheibe in der Vertikalen ausrichten. Ein zusätzliches Feature sind die Easy Glass Bauanschlussleisten für eine nahtlose Verbindung mit dem angrenzenden Boden. Diese sorgen für ein stilvolles Finish und einen erhöhten Materialschutz.

Easy Glass® Smart

Max. Holmlast (kN/m)

DE

1,0

STATISCHE
BERECHNUNG
DIN18008

AbP
BALIAST
GEPRÜFT

Bitte beachten Sie die Spezifikationen wie Befestigungs- und Glasmaße sowie Glastypen der jeweiligen Zertifikate.

International getestet/berechnet/zertifiziert:



- 1 Mit dem justierbaren Q-disc System können Sie die Glasfüllung nicht nur fixieren, sondern auch um 0,6° in der Vertikalen ausrichten.
- 2 Mit einem Klickgeräusch signalisiert die Q-disc die korrekte Installation.
- 3 Geeignet für Glasstärken zwischen 12 und 21,52 mm.



EASY GLASS® SMART MONTAGEOPTIONEN

Smart

Bodenmontage

- Auch für die In-Bodenmontage

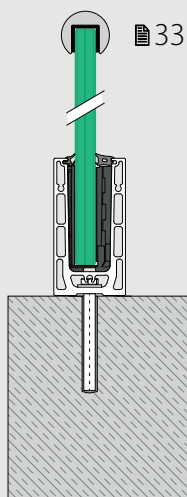

Smart F

Bodenmontage

- Für Rohfußböden
- Kann direkt an oder über der Bodenkante angebracht werden

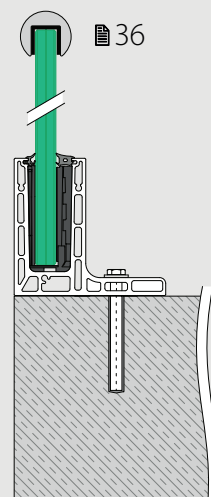

Smart

Seitenmontage

- Auch zur Montage an der Innenseite von Aufmauerungen
- Bodenprofil-Blendeleiste erhältlich

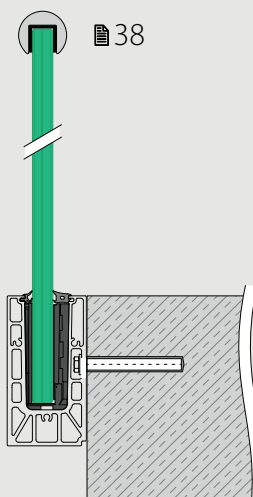

Smart Y

Seitenmontage

- Für Rohfußböden
- Kann direkt an oder über der Bodenkante angebracht werden
- Bodenprofil-Blendeleiste erhältlich

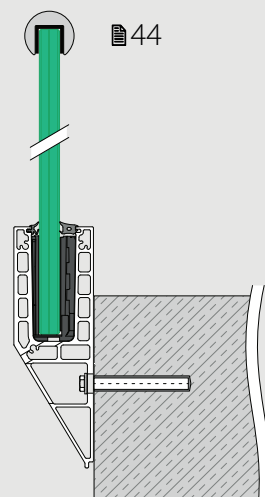



JUSTIERBARES Q-DISC® SYSTEM SCHIEBEN UND AUSRICHTEN!



SO FUNKTIONIERT'S

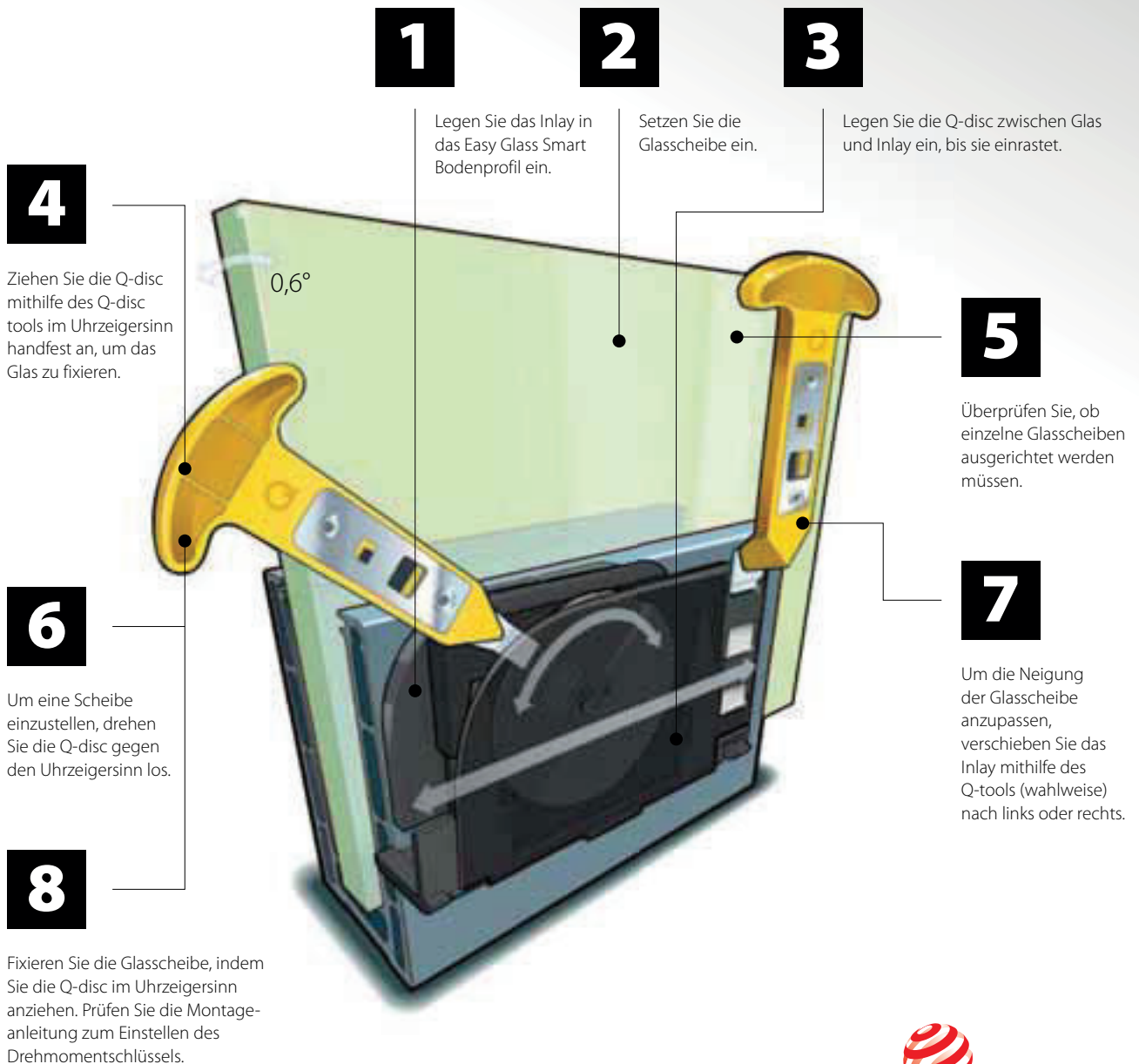

reddot winner 2020
innovative product

Q-disc® System (Gummi, Inlay und Q-disc®)

Glasklemmung und -justierung

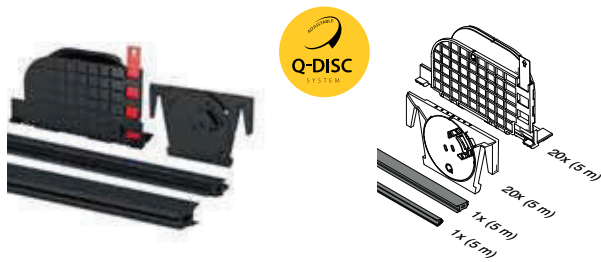

MOD 8201

Zubehör

Für monolithisches Glas		
	T	
208201-050-12	12	L = 5 m
208201-050-15	15	L = 5 m
208201-250-12	12	L = 25 m
208201-250-15	15	L = 25 m
Für laminiertes Glas		
208201-050-13	12,76	L = 5 m
208201-050-14	13,52	L = 5 m
208201-050-17	16,76	L = 5 m
208201-050-18	17,52	L = 5 m
208201-250-13	12,76	L = 25 m
208201-250-14	13,52	L = 25 m
208201-250-17	16,76	L = 25 m
208201-250-18	17,52	L = 25 m



Internationaler Geschmacksmusterschutz

Zubehör

Q-disc®- und Inlay-Werkzeug



MOD 1000

Zubehör

	Q	
201000	Q-84	1

Zubehör

Einzelne Gummis



MOD 8207

Zubehör

208207-250-00	L = 25 m

NEW



MOD 8207

Zubehör

Für monolithisches Glas		
	T	
208207-250-12	12	L = 25 m
208207-250-15	15	L = 25 m

Für laminiertes Glas

208207-250-14	12,76 - 13,52	L = 25 m
208207-250-18	16,76 - 17,52	L = 25 m

NEW

Zubehör

Q-disc®-Sets

Glasklemmung und -justierung



MOD 8209

Zubehör

Für monolithisches Glas		
	T	
208209-12	12	5
208209-15	15	5

Für laminiertes Glas

208209-13	12,76	5
208209-14	13,52	5
208209-17	16,76	5
208209-18	17,52	5

NEW



Q-INFO MOD 1000

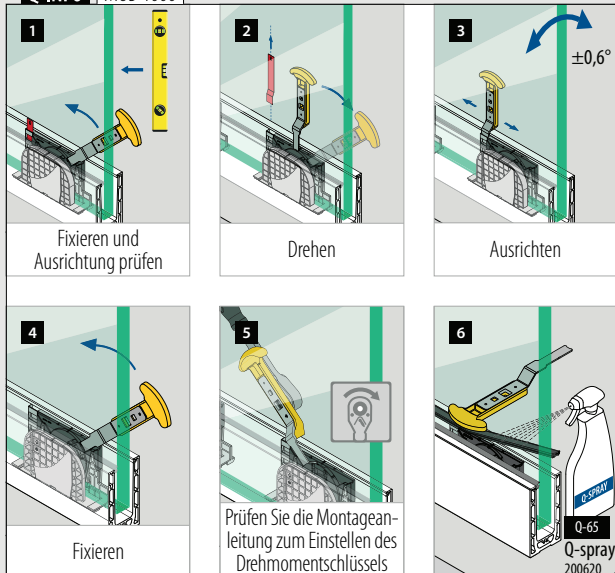

Q-INFO

Installationsblech

MOD 1002

482



Geländerbasis

Q-disc® System (Gummi, Inlay und Q-disc®)

Glasklemmung (nicht justierbar)

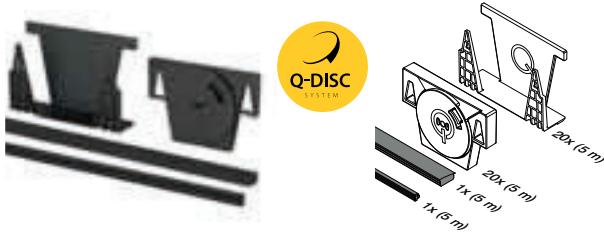

MOD 8200

Zubehör

Für monolithisches Glas		
SELL OUT	T	
208200-050-12	12	L = 5 m
208200-050-15	15	L = 5 m
208200-050-19	19	L = 5 m

Für laminiertes Glas

SELL OUT			
208200-050-13	12,76 - 13,52	L = 5 m	
208200-050-17	16,76 - 17,52	L = 5 m	
208200-050-21	20,76 - 21,52	L = 5 m	

SELL OUT			
208200-250-13	12,76 - 13,52	L = 25 m	
208200-250-17	16,76 - 17,52	L = 25 m	
208200-250-21	20,76 - 21,52	L = 25 m	



Internationaler Geschmacksmusterschutz

Zubehör

Q-disc®- und Inlay-Werkzeug

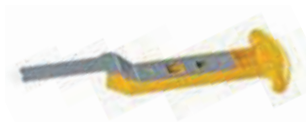

MOD 1000

Zubehör

Für monolithisches Glas		
SELL OUT	Q	
201000	Q-84	1

SELL OUT Nur solange der Vorrat reicht.

Zubehör

Einzelne Gummis



MOD 8206

Zubehör

Für monolithisches Glas		
SELL OUT	T	
208206-250-00		L = 25 m

NEW



MOD 8206

Zubehör

Für laminiertes Glas		
SELL OUT	T	
208206-250-13	12,76 - 13,52	L = 25 m
208206-250-17	16,76 - 17,52	L = 25 m
208206-250-21	20,76 - 21,52	L = 25 m

NEW

Zubehör

Q-disc®-Sets

Glasklemmung (nicht justierbar)



MOD 8208

Zubehör

Für monolithisches Glas		
SELL OUT	T	
208208-12	12	5
208208-15	15	5
208208-19	19	5

Für laminiertes Glas

SELL OUT			
208208-13	12,76 - 13,52	5	
208208-17	16,76 - 17,52	5	
208208-21	20,76 - 21,52	5	

NEW



Q-INFO | MOD 1000



Bodenprofile zur Bodenmontage

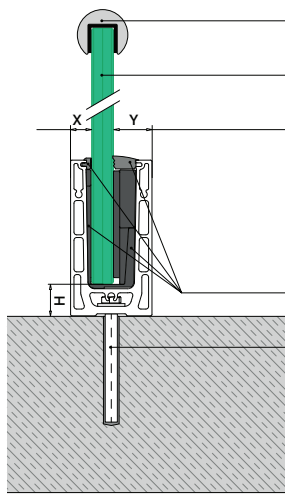

Glasleistenrohre: ■ 169 - 185
Kantenschutz: ■ 166 - 168

VSG aus ESG: ■ 160 - 161

Glasklemmung und -justierung
X = variabel X = 15
Y = 25,5 Y = variabel
H = 25 H = 23

Q-disc® System: ■ 31, 32

Anker: ■ 459 - 465

Bitte beachten Sie die Spezifikationen wie Befestigungs- und Glasmaße sowie Glastypen der jeweiligen Zertifikate und statischen Berechnungen.

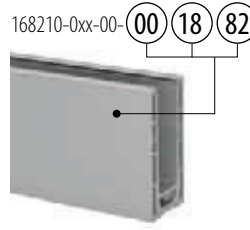

Inklusive Verbindungsstifte

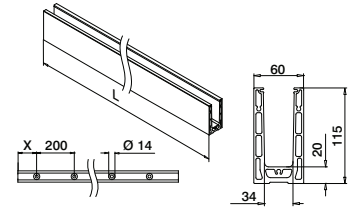

MOD 8210

Aluminium Roh			
	X		
168210-050-00-00	100	■ 459 - 465	L = 5 m

Aluminium Gebürstet			
OUTDOOR			

168210-025-00-18	50	■ 459 - 465	L = 2,5 m
168210-050-00-18	100	■ 459 - 465	L = 5 m

Aluminium Black Line			
OUTDOOR			

NEW 168210-050-00-82	100	■ 459 - 465	L = 5 m
-----------------------------	-----	-------------	---------



Internationaler Geschmacksmusterenschutz

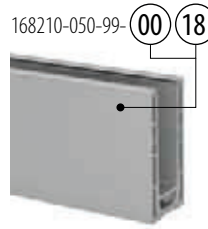

Ohne Löcher

Inklusive Verbindungsstifte

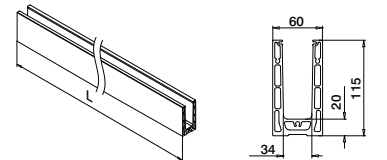

MOD 8210

Aluminium Roh			
168210-050-99-00			L = 5 m

Aluminium Gebürstet			
OUTDOOR			

168210-050-99-18			L = 5 m
------------------	--	--	---------



Internationaler Geschmacksmusterenschutz

Q-INFO

Bauanschlussleisten: ■ 48 - 49

MOD 8205 ■ 48

Bauanschlussleisten-/Trenngummi

Q-INFO

PREFIX

Q-INFO

MOD 3005
■ 480

Zusätzliche Verbindungsstifte

Q-INFO Aluminium

00	18	82 RAL 9005
Roh	Gebürstet, anodisiert	Pulverbeschichtet

Geländerbasis

Ecken zur Bodenmontage

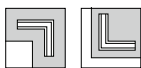

Innen- und Außenecke

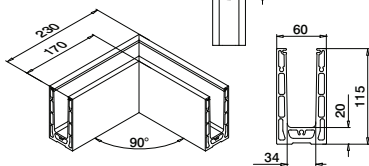

MOD 8211

Aluminium	Roh		
168211-00-00		459 - 465	1
Aluminium	Gebürstet		
OUTDOOR			
168211-00-18		459 - 465	1
Aluminium	Black Line		
OUTDOOR			
NEW 168211-00-82		459 - 465	1



Internationaler Geschmacksmusterschutz

Geländerbasis

Endkappen zur Bodenmontage



Links / rechts

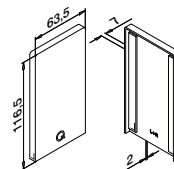

MOD 8212

Aluminium	Roh		
	Klebeband		
168212-00-00	Beigelegt		1
Aluminium	Gebürstet		
OUTDOOR			
168212-00-18	Angebracht		1
Aluminium	Black Line		
OUTDOOR			
NEW 168212-00-82	Beigelegt		1

Q-INFO MOD 8212

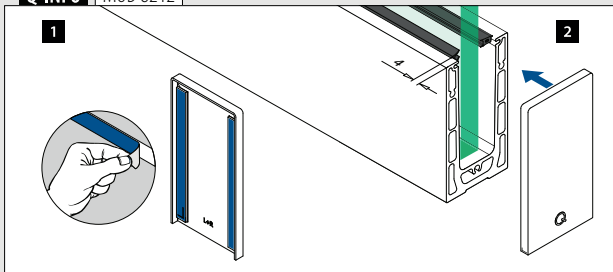

Q-INFO Aluminium

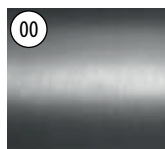

Roh

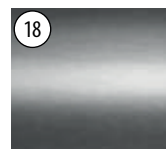

Gebürstet, anodisiert



Schwarz, matt, strukturiert

Endkappen zur Bodenmontage

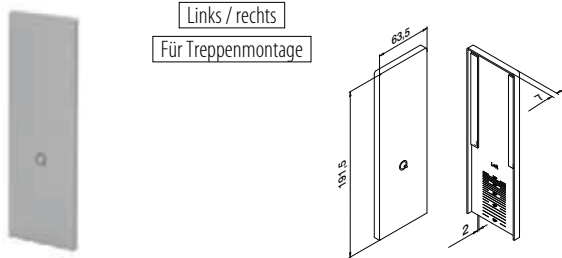

MOD 8213

Aluminium	Roh		
		Klebeband	
168213-00-00	Beigelegt		1
Aluminium	Gebürstet		
		OUTDOOR	
168213-00-18	Angebracht		1



Unterlegscheiben zur Bodenmontage

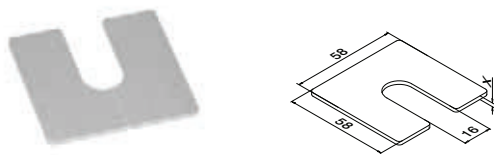

MOD 8216

Aluminium	Roh		
		X	
168216-001	1		100
168216-002	2		100
168216-003	3		100

Drainageleisten zur Bodenmontage

4 Stück für 2,5-Meter-Bodenprofil
8 Stück für 5-Meter-Bodenprofil

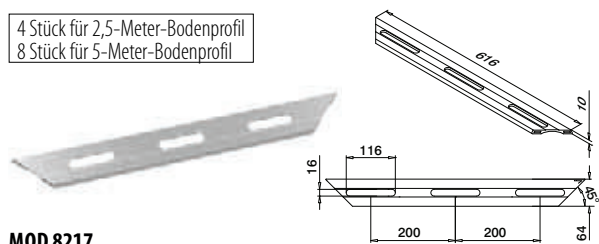

MOD 8217

Aluminium	Gebürstet		
		OUTDOOR	
168217-18			4

Q-INFO MOD 8213

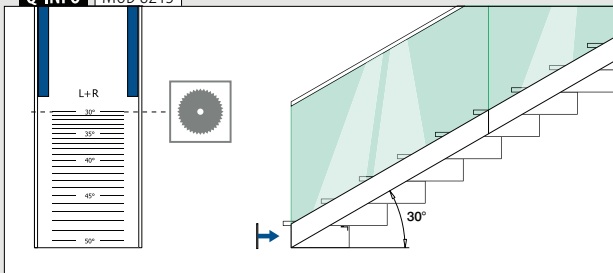

Q-INFO MOD 8216

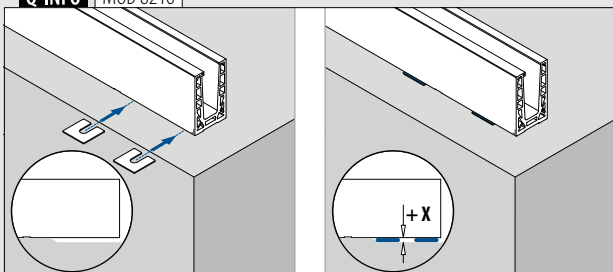

Q-INFO MOD 8217

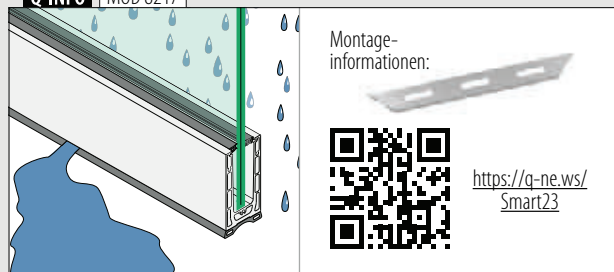

<https://q-ne.ws/Smart23>

Bodenprofile zur Bodenmontage

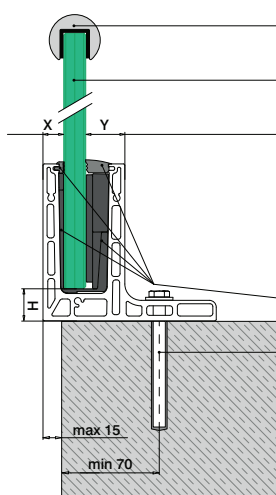

Glasleistenrohre: ■ 169 - 185
Kantenschutz: ■ 166 - 168

VSG aus ESG: ■ 160 - 161

Glaskehlung und -justierung
X = variabel
Y = 25,5
H = 25

Zur nicht justierbaren Glaskehlung
X = 15,5
Y = variabel
H = 23

Q-disc® System: ■ 31, 32

Anker: ■ 459 - 465

Bitte beachten Sie die Spezifikationen wie Befestigungs- und Glasmaße sowie Glastypeen der jeweiligen Zertifikate und statischen Berechnungen.

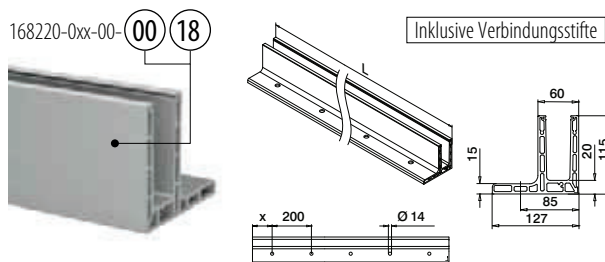

MOD 8220

Aluminium	Roh		
	X		
168220-050-00-00	100	■ 459 - 465	L = 5 m
Aluminium	Gebürstet		
OUTDOOR			
168220-025-00-18	50	■ 459 - 465	L = 2,5 m
168220-050-00-18	100	■ 459 - 465	L = 5 m



Internationaler Geschmacksmusterschutz

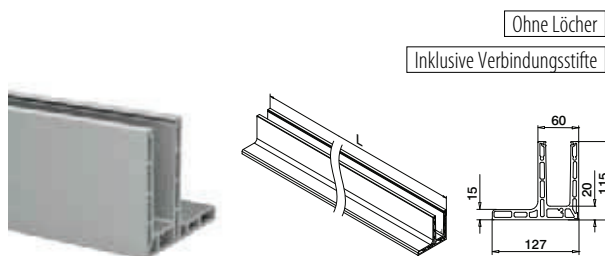

MOD 8220

Aluminium	Gebürstet		
168220-050-99-18			L = 5 m



Internationaler Geschmacksmusterschutz

Q-INFO

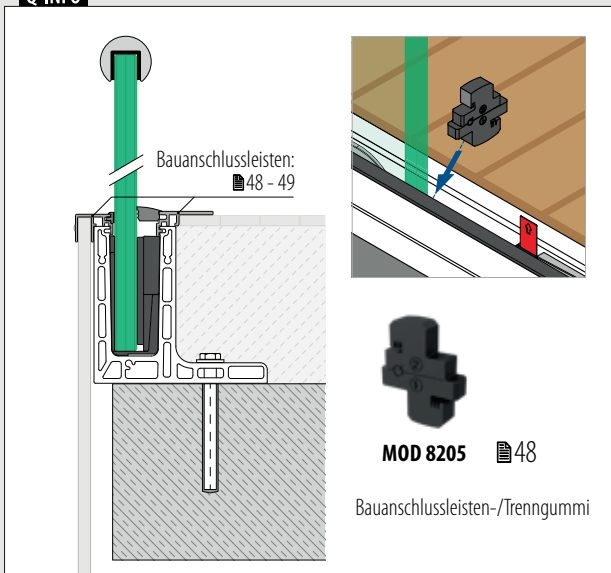

Q-INFO

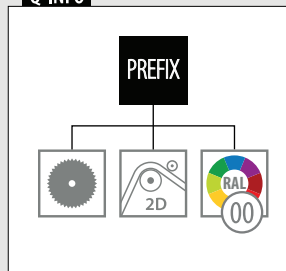

Q-INFO Aluminium



Q-INFO

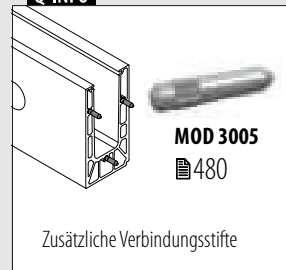

Ecken zur Bodenmontage

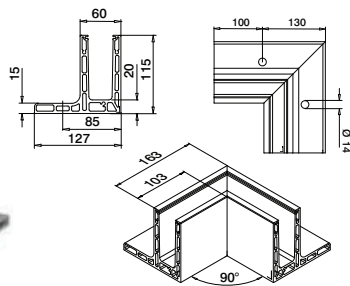
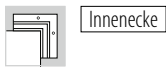

MOD 8221

Aluminium	Gebürstet		
OUTDOOR			
168221-01-18	459 - 465		1



Internationaler Geschmacksmusterschutz

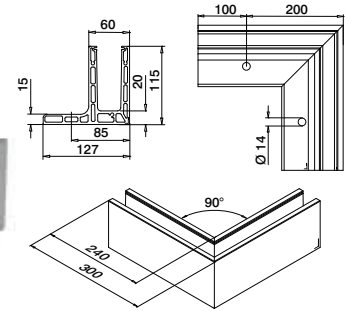

MOD 8221

Aluminium	Gebürstet		
OUTDOOR			
168221-02-18	459 - 465		1



Internationaler Geschmacksmusterschutz

Endkappen zur Bodenmontage



Links

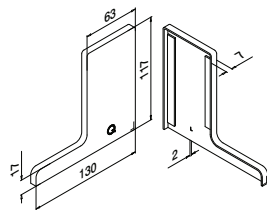

MOD 8222

Aluminium	Roh		
Klebeband			
168222-01-00	Beigelegt		1
Aluminium	Gebürstet		
OUTDOOR			
168222-01-18	Angebracht		1



Rechts

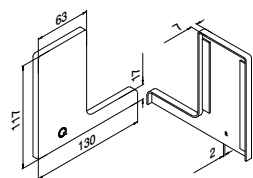

MOD 8222

Aluminium	Roh		
Klebeband			
168222-02-00	Beigelegt		1
Aluminium	Gebürstet		
OUTDOOR			
168222-02-18	Angebracht		1

Wasserdichte Verkleidungen

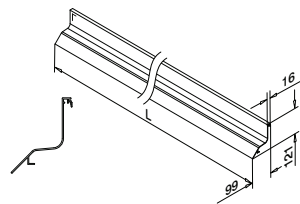

MOD 6980

Aluminium	Roh		
Klebeband			
166980-50-00	Nicht inkl.*		1
Aluminium	Gebürstet		
OUTDOOR			
166980-50-18	Nicht inkl.*		1

NEW

*Bestellen Sie MOD 1360 (Klebeband)

Acrylat-Klebeband



MOD 1360

Zubehör				
	Q	W	L	
201360	Q-53	9	33 m	1

Q-INFO MOD 8222

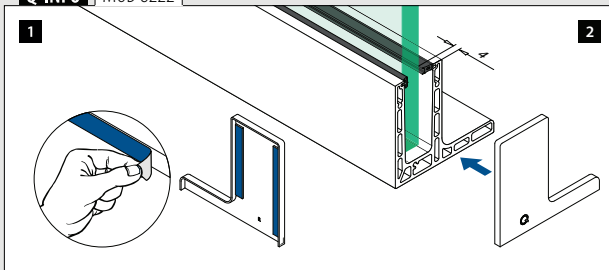

Q-INFO MOD 6980

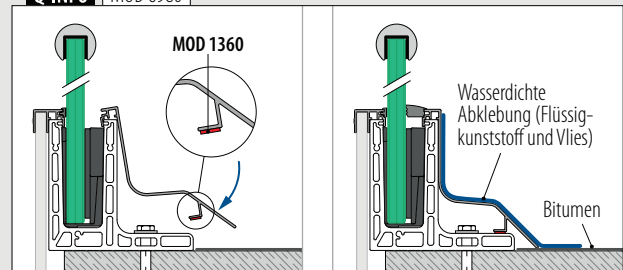

Geländerbasis

Bodenprofile zur Seitenmontage

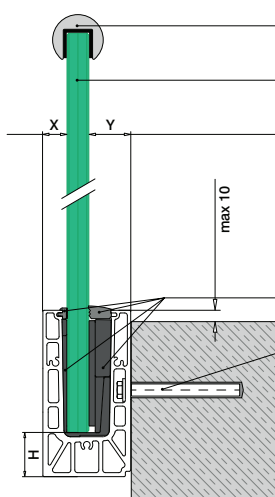

Glasleistenrohre: ■ 169 - 185
Kantenschutz: ■ 166 - 168

VSG aus ESG: ■ 160 - 161

Glaskehlung und -justierung
X = variabel
Y = 28,5
H = 35

Zur nicht justierbaren Glaskehlung
X = 18,5
Y = variabel
H = 33

Q-disc® System: ■ 31, 32

Anker: ■ 459 - 465

Bitte beachten Sie die Spezifikationen wie Befestigungs- und Glasmaße sowie Glastypen der jeweiligen Zertifikate und statischen Berechnungen.

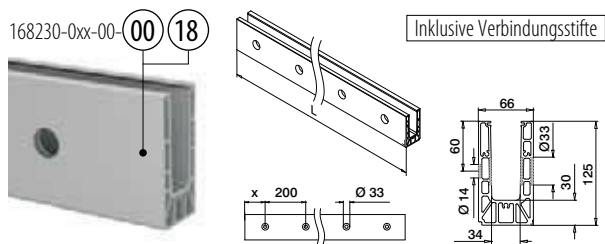

MOD 8230

Aluminium	Roh	X		
168230-050-00-00	100	■ 459 - 465	L = 5 m	
Aluminium	Gebürstet			
OUTDOOR				
168230-025-00-18	50	■ 459 - 465	L = 2,5 m	
168230-050-00-18	100	■ 459 - 465	L = 5 m	



Internationaler Geschmacksmusterschutz

Geländerbasis

Ecken zur Seitenmontage

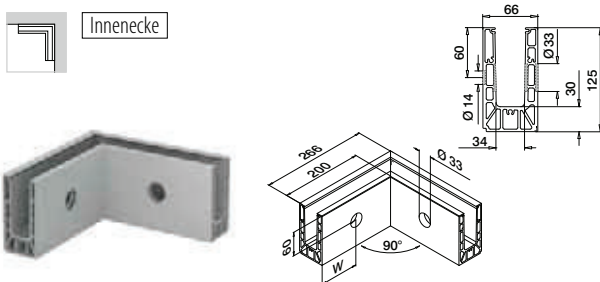

MOD 8231

Aluminium	Roh	W		
168231-01-00	100*	■ 459 - 465	1	
Aluminium	Gebürstet			
OUTDOOR				
168231-01-18	100*	■ 459 - 465	1	



Internationaler Geschmacksmusterschutz

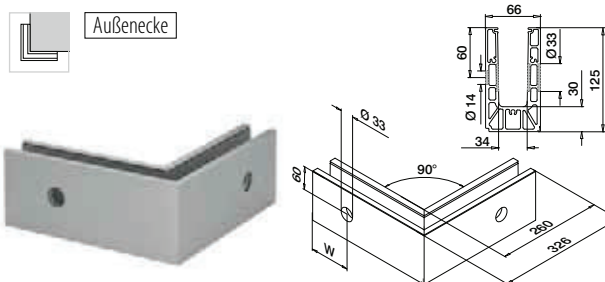

MOD 8231

Aluminium	Roh	W		
168231-02-00	100*	■ 459 - 465	1	
Aluminium	Gebürstet			
OUTDOOR				
168231-02-18	100*	■ 459 - 465	1	



Internationaler Geschmacksmusterschutz

*Die Lochposition kann produktionsbedingt abweichen.

Q-INFO MOD 8230

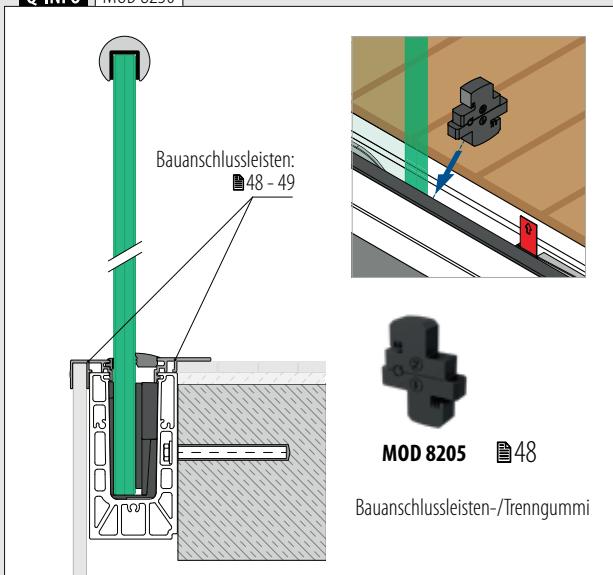

Q-INFO MOD 8230

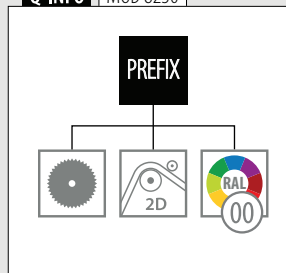

Q-INFO Aluminium



Q-INFO



Endkappen zur Seitenmontage

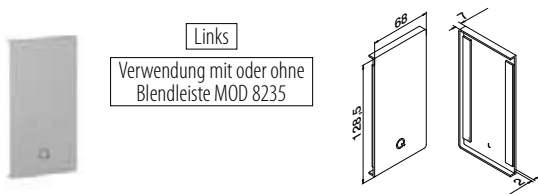

MOD 8232

Aluminium	Roh		
	Klebeband		
168232-01-00	Beigelegt	1	
Aluminium	Gebürstet		
OUTDOOR			
168232-01-18	Angebracht	1	

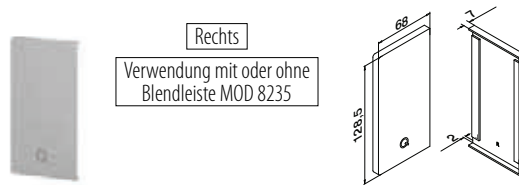

MOD 8232

Aluminium	Roh		
	Klebeband		
168232-02-00	Beigelegt	1	
Aluminium	Gebürstet		
OUTDOOR			
168232-02-18	Angebracht	1	

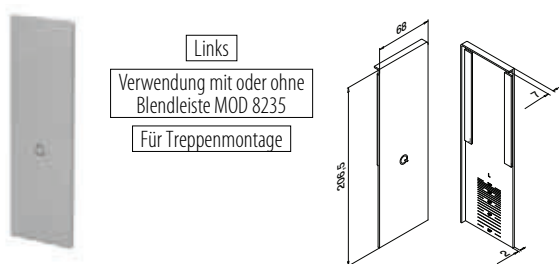

MOD 8233

Aluminium	Roh		
	Klebeband		
168233-01-00	Beigelegt	1	
Aluminium	Gebürstet		
OUTDOOR			
168233-01-18	Angebracht	1	

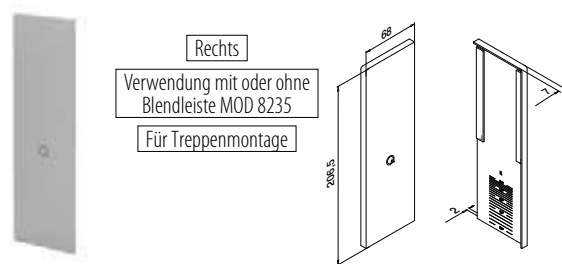

MOD 8233

Aluminium	Roh		
	Klebeband		
168233-02-00	Beigelegt	1	
Aluminium	Gebürstet		
OUTDOOR			
168233-02-18	Angebracht	1	



Q-INFO Aluminium

00

Roh

18

Gebürstet,
anodisiert

Q-INFO MOD 8232 / 8233

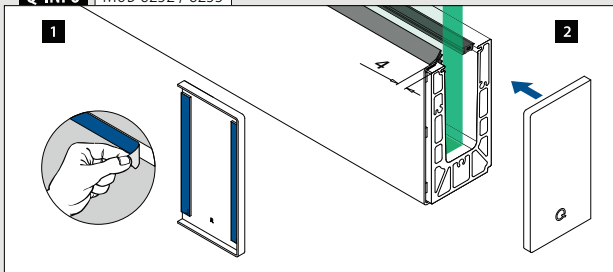

Q-INFO MOD 8233

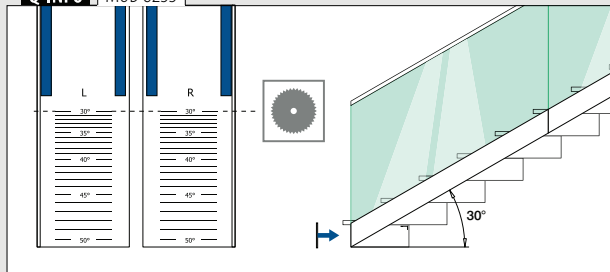

Geländerbasis

Endkappen zur Seitenmontage

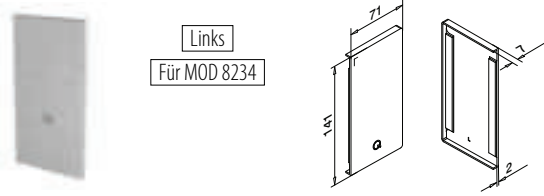

Links
Für MOD 8234

MOD 8232

Aluminium	Roh	Klebeband	
168232-41-00	Beigelegt		1
Aluminium	Gebürstet		
OUTDOOR			
168232-41-18	Angebracht		1

NEW

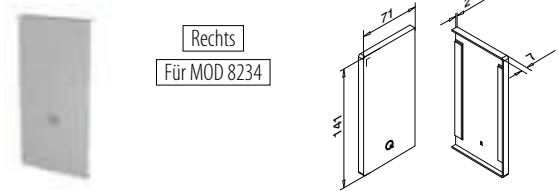

Rechts
Für MOD 8234

MOD 8232

Aluminium	Roh	Klebeband	
168232-42-00	Beigelegt		1
Aluminium	Gebürstet		
OUTDOOR			
168232-42-18	Angebracht		1

NEW

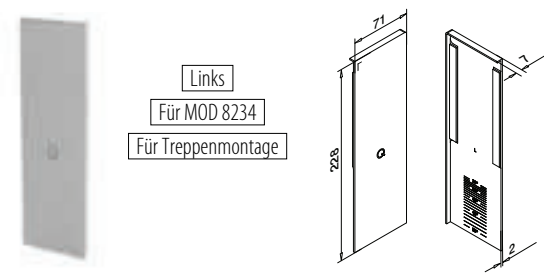

Links
Für MOD 8234
Für Treppenmontage

MOD 8233

Aluminium	Gebürstet		
OUTDOOR		Klebeband	
168233-41-18	Angebracht		1

NEW

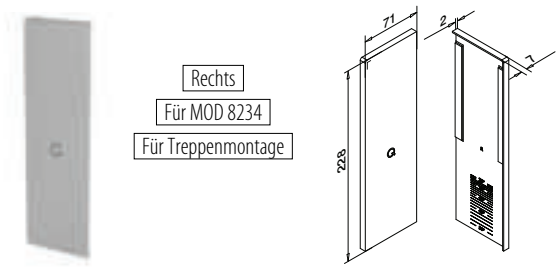

Rechts
Für MOD 8234
Für Treppenmontage

MOD 8233

Aluminium	Gebürstet		
OUTDOOR		Klebeband	
168233-42-18	Angebracht		1

NEW



Q-INFO Aluminium

00

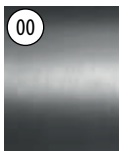

Roh

18

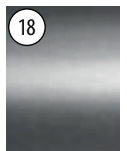

Gebürstet,
anodisiert

Drainageleisten zur Seitenmontage

4 Stück für 2,5-Meter-Bodenprofil
8 Stück für 5-Meter-Bodenprofil

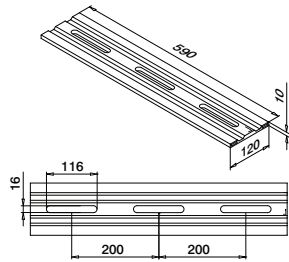

MOD 8237

Aluminium Gebürstet
OUTDOOR

168237-18



4

Blendstopfen zur Seitenmontage



Verwendung
ohne Blendeiste

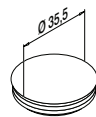

MOD 8238

Kunststoff Aluminium RAL 9006
INDOOR

158238-36



10

Unterlegscheiben zur Seitenmontage

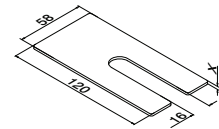

MOD 8236

Aluminium Roh

X

168236-001

1

100

168236-002

2

100

168236-003

3

100

Glas-Stopp



Für Treppenmontage

MOD 8204

Zubehör



208204

1

NEW

Q-INFO MOD 8237

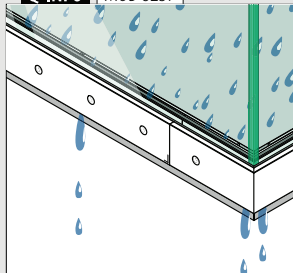

Montage-
informationen:



[https://q-ne.ws/
Smart23](https://q-ne.ws/Smart23)



Q-INFO MOD 8236

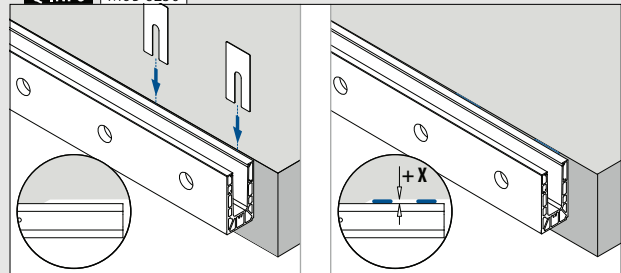

Q-INFO MOD 8238

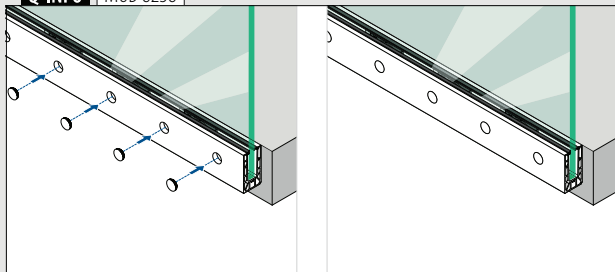

Q-INFO MOD 8204

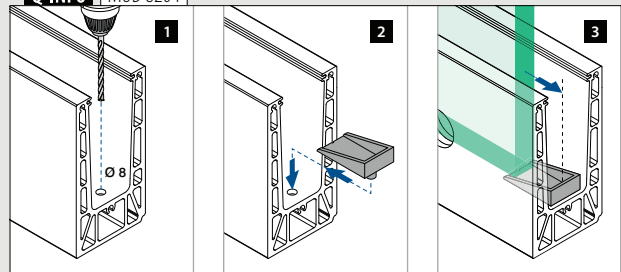

Geländerbasis

Blendleisten zur Seitenmontage

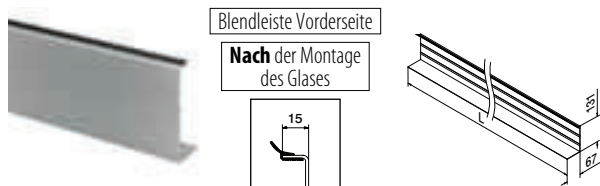

MOD 8235

Aluminium	Roh	Klebeband	
SELL OUT 168235-050-00		Nicht inkl.*	L = 5 m

Aluminium	Gebürstet		
OUTDOOR			

SELL OUT 168235-050-18	Angebracht	L = 5 m	
------------------------	------------	---------	--



*Bestellen Sie MOD 1360 (Klebeband)



MOD 8234

Aluminium	Roh	Klebeband	
168234-050-00			L = 5 m

Aluminium	Gebürstet		
OUTDOOR			

168234-050-18		L = 5 m	
---------------	--	---------	--



Zubehör

Acrylat-Klebeband



MOD 1360

Zubehör	Q	W	L	
201360	Q-53	9	33 m (für 11 m Blendleiste)	1

SELL OUT Nur solange der Vorrat reicht.

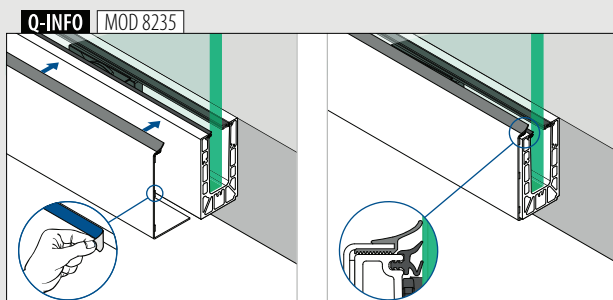

Q-INFO MOD 8235-050-00 / 1360

Montage-Informationen:

<https://q-n.e.ws/Smart23>

Q-INFO **Aluminium**

00	18
Roh	Gebürstet, anodisiert

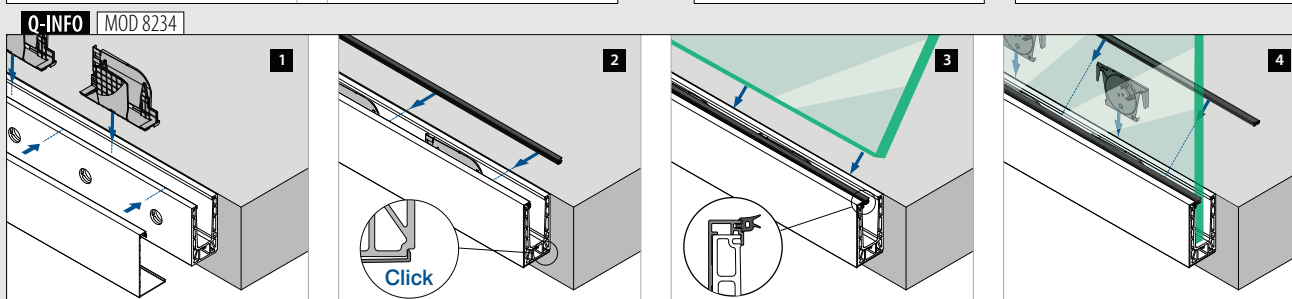



Bodenprofile zur Seitenmontage

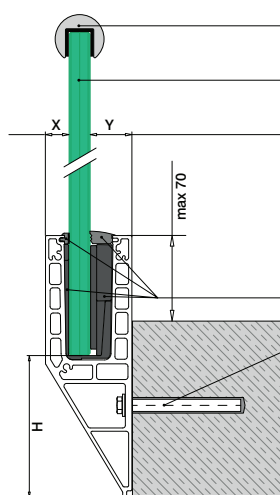

Glasleistenrohre: ■ 169 - 185
Kantenschutz: ■ 166 - 168

VSG aus ESG: ■ 160 - 161

Glaskehlung und -justierung
X = variabel
Y = 28,5
H = 140

Zur nicht justierbaren Glaskehlung
X = 18,5
Y = variabel
H = 138

Q-disc® System: ■ 31, 32

Anker: ■ 459 - 465

Bitte beachten Sie die Spezifikationen wie Befestigungs- und Glasmaße sowie Glastypeen der jeweiligen Zertifikate und statischen Berechnungen.

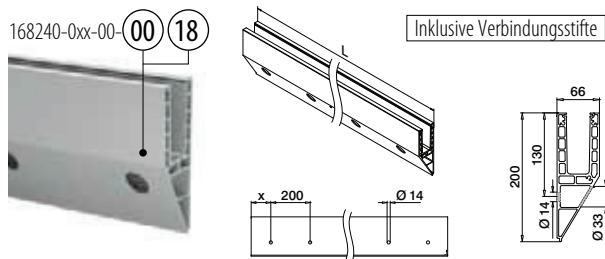

MOD 8240

Aluminium	Roh		
	X		
168240-050-00-00	100	■ 459 - 465	L = 5 m
Aluminium	Gebürstet		
OUTDOOR			
168240-025-00-18	50	■ 459 - 465	L = 2,5 m
168240-050-00-18	100	■ 459 - 465	L = 5 m



Internationaler Geschmacksmusterschutz

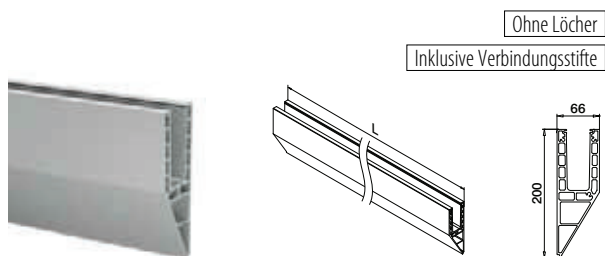

MOD 8240

Aluminium	Gebürstet		
168240-050-99-18		■ 459 - 465	L = 5 m



Internationaler Geschmacksmusterschutz

Q-INFO

Bauanschlussleisten: ■ 48 - 49

MOD 8205 ■ 48

Bauanschlussleisten-/Trenngummi

Q-INFO

Q-INFO Aluminium

00	18
Roh	Gebürstet, anodisiert

Q-INFO

MOD 3005 ■ 480

Zusätzliche Verbindungsstifte

Ecken zur Seitenmontage

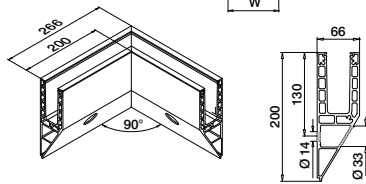
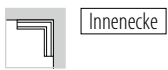

MOD 8241

Aluminium	Gebürstet		
OUTDOOR	W		
168241-01-18	100*	459 - 465	1



Internationaler Geschmacksmusterschutz

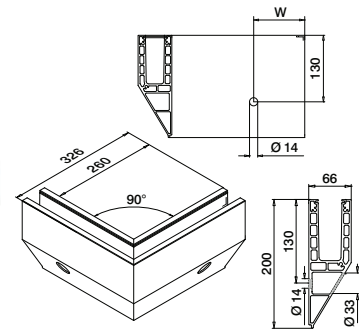

MOD 8241

Aluminium	Gebürstet		
OUTDOOR	W		
168241-02-18	100*	459 - 465	1



Internationaler Geschmacksmusterschutz

*Die Lochposition kann produktionsbedingt abweichen.

Endkappen zur Seitenmontage



Links
Verwendung
ohne Blendleiste

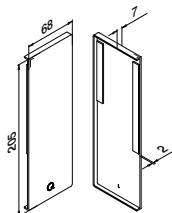

MOD 8242

Aluminium	Roh		
	Kleband		
168242-01-00	Beigelegt		1
Aluminium	Gebürstet		
OUTDOOR			
168242-01-18	Angebracht		1



Rechts
Verwendung
ohne Blendleiste

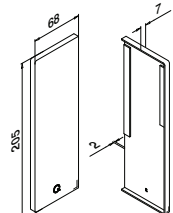

MOD 8242

Aluminium	Roh		
	Kleband		
168242-02-00	Beigelegt		1
Aluminium	Gebürstet		
OUTDOOR			
168242-02-18	Angebracht		1



Links
Verwendung mit oder ohne
Blendleiste MOD 8245
Für Treppmontage

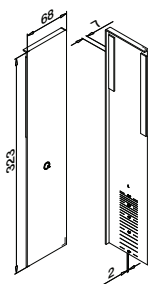

MOD 8243

Aluminium	Gebürstet		
OUTDOOR	Kleband		
168243-01-18	Angebracht		1



Rechts
Verwendung mit oder ohne
Blendleiste MOD 8245
Für Treppmontage

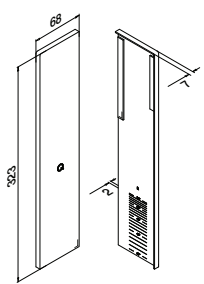

MOD 8243

Aluminium	Gebürstet		
OUTDOOR	Kleband		
168243-02-18	Angebracht		1



Q-INFO MOD 8242 / 8243

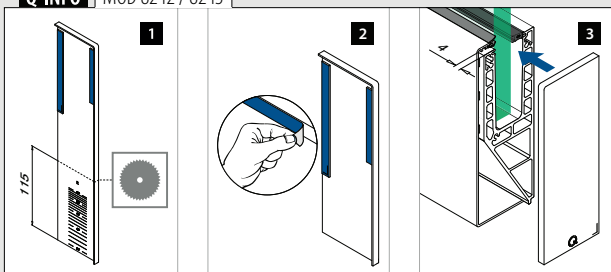

Q-INFO MOD 8243

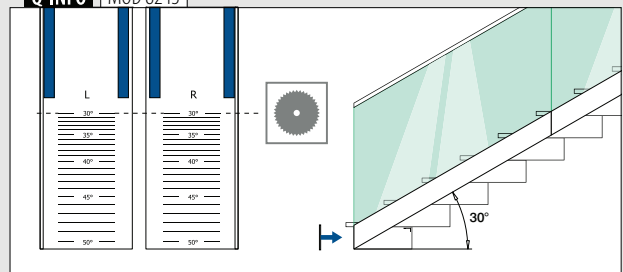

Geländerbasis

Endkappen zur Seitenmontage

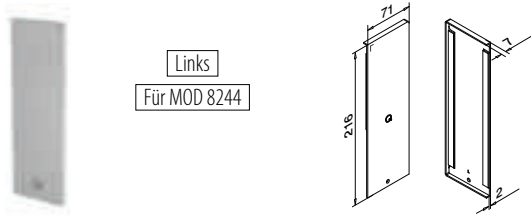

Links
Für MOD 8244

MOD 8242

Aluminium Roh	Klebeband	
168242-41-00	Beigelegt	1
Aluminium Gebürstet		
OUTDOOR		
168242-41-18	Angebracht	1

NEW

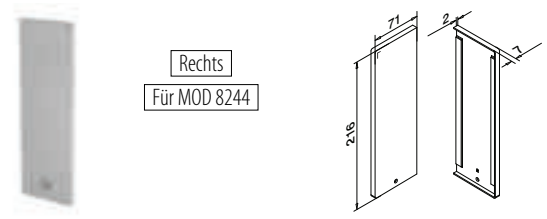

Rechts
Für MOD 8244

MOD 8242

Aluminium Roh	Klebeband	
168242-42-00	Beigelegt	1
Aluminium Gebürstet		
OUTDOOR		
168242-42-18	Angebracht	1

NEW

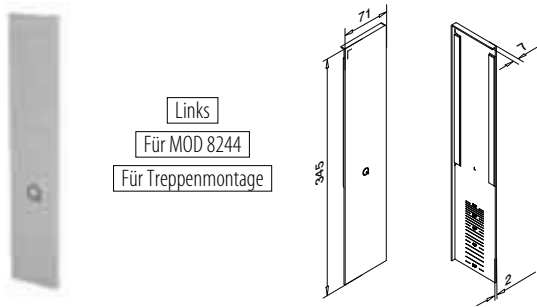

Links
Für MOD 8244
Für Treppenmontage

MOD 8243

Aluminium Gebürstet	Klebeband	
168243-41-18	Angebracht	1

NEW

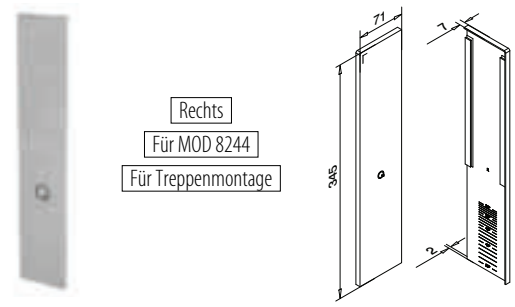

Rechts
Für MOD 8244
Für Treppenmontage

MOD 8243

Aluminium Gebürstet	Klebeband	
168243-42-18	Angebracht	1

NEW



Geländerbasis

Glas-Stopp



MOD 8204

Zubehör		
208204		1

NEW

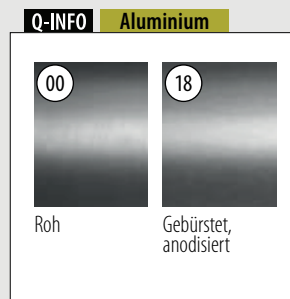
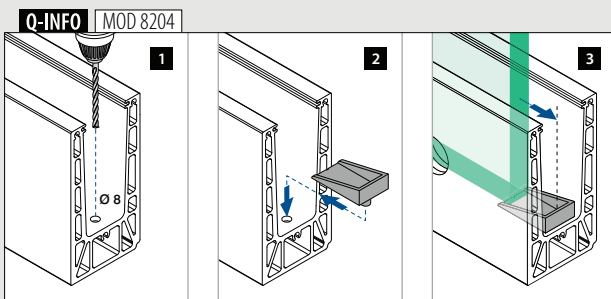

Blendleisten zur Seitenmontage

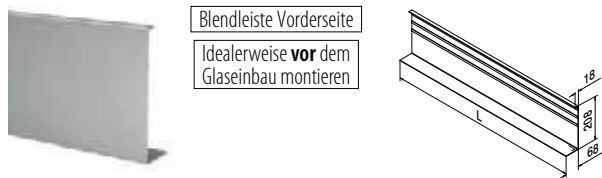

MOD 8245

Aluminium	Roh		
		Klebeband	
SELL OUT	168245-050-00	Nicht inkl.*	L = 5 m
Aluminium	Gebürstet		
		OUTDOOR	
SELL OUT	168245-050-18	Angebracht	L = 5 m



*Bestellen Sie MOD 1360 (Klebeband)

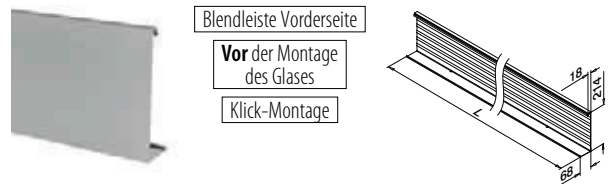

MOD 8244

Aluminium	Roh		
		Klebeband	
	168244-050-00		L = 5 m
Aluminium	Gebürstet		
		OUTDOOR	
	168244-050-18		L = 5 m



Zubehör

Acrylat-Klebeband



MOD 1360

		Zubehör			
	Q	W	L		
	201360	Q-53	9	33 m (für 11 m Blendleiste)	1

Q-INFO MOD 8245-050-00 / 1360

Montage-Informationen:



SELL OUT Nur solange der Vorrat reicht.

Q-INFO MOD 8245

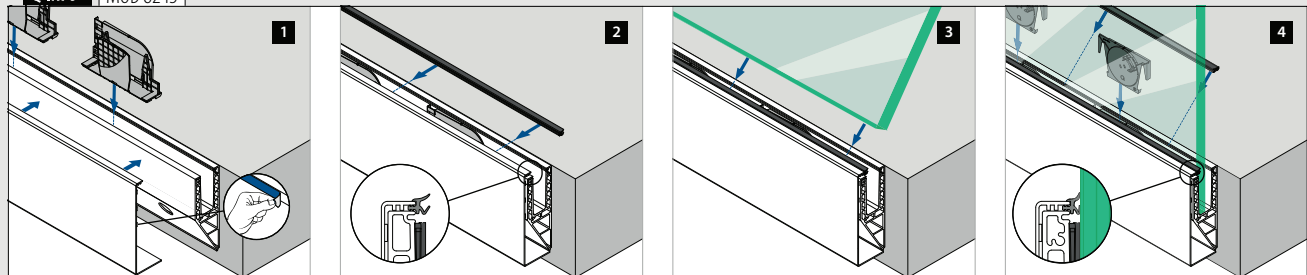

Q-INFO MOD 8244

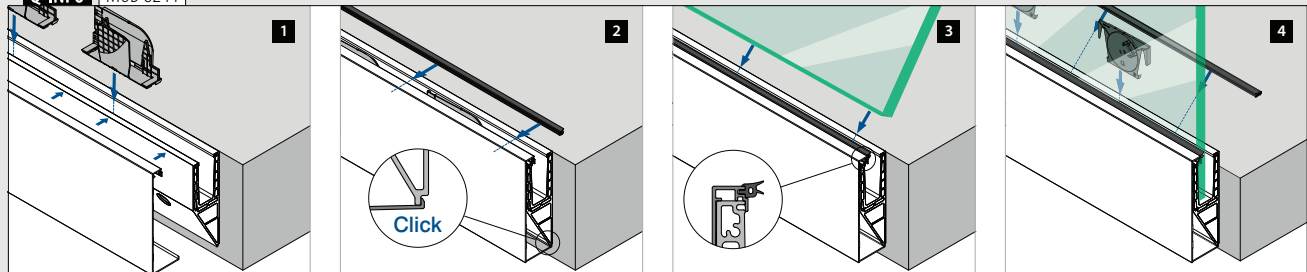

Geländerbasis

Bauanschlussleisten zur Bodenmontage

Für alle Smart-Profile

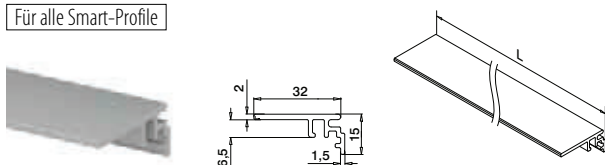

MOD 6973

Aluminium	Roh	
166973-50-00		L = 5 m
Aluminium	Gebürstet	
OUTDOOR		
166973-50-18		L = 5 m

PREFIX

Für Smart Bodenmontage- und F-Profile

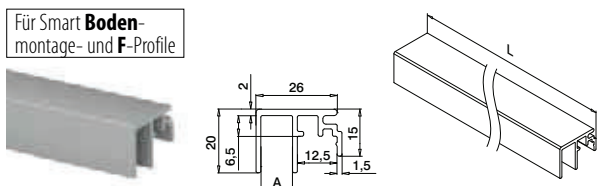

MOD 6972

Aluminium	Roh	
	A	
166972-010-50-00	10	L = 5 m
Aluminium	Gebürstet	
OUTDOOR		
166972-010-50-18	10	L = 5 m

PREFIX

Für alle Smart-Profile

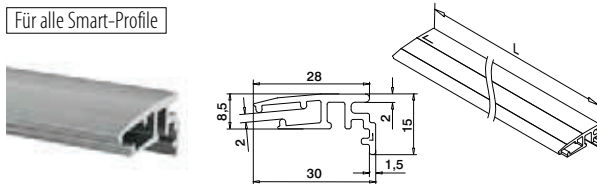

MOD 6979

Aluminium	Roh	
166979-002-50-00		L = 5 m
Aluminium	Gebürstet	
OUTDOOR		
166979-002-50-18		L = 5 m

NEW

PREFIX

Für Smart Bodenmontage- und F-Profile

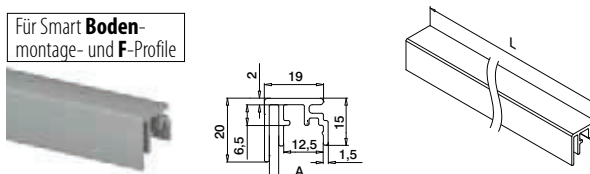

MOD 6972

Aluminium	Roh	
	A	
166972-003-50-00	3	L = 5 m
Aluminium	Gebürstet	
OUTDOOR		
166972-003-50-18	3	L = 5 m

PREFIX

Für Smart Bodenmontage- und F-Profile

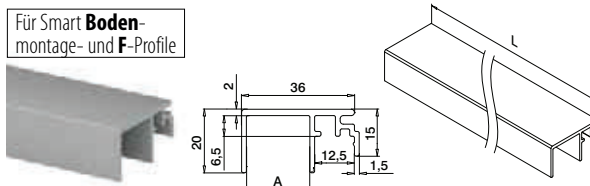

MOD 6972

Aluminium	Roh	
	A	
166972-020-50-00	20	L = 5 m
Aluminium	Gebürstet	
OUTDOOR		
166972-020-50-18	20	L = 5 m

PREFIX

Geländerbasis

Bauanschlussleisten-/Trenngummi

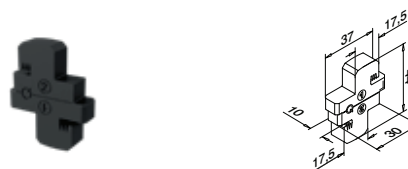

MOD 8205

Zubehör	
208205-010	5



Q-INFO Aluminium

Roh	Gebürstet, anodisiert

Q-INFO

PREFIX

Q-INFO MOD 8205

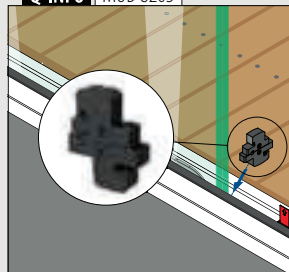

Bauanschlussleisten zur Seitenmontage

Für alle Smart-Profile

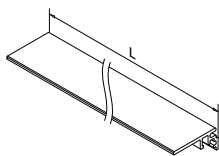
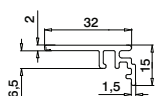

MOD 6973

Aluminium	Roh		
166973-50-00		L = 5 m	
Aluminium	Gebürstet		
OUTDOOR			
166973-50-18		L = 5 m	

PREFIX

Für Smart **Seiten-**
montage- und Y-Profile

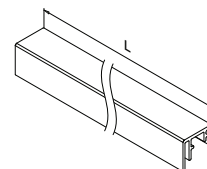
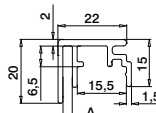

MOD 6970

Aluminium	Roh	A	
166970-003-50-00		3	L = 5 m
Aluminium	Gebürstet		
OUTDOOR			
166970-003-50-18		3	L = 5 m

PREFIX

Für Smart **Seiten-**
montage- und Y-Profile

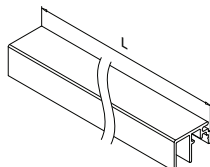
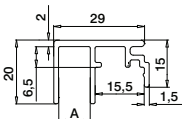

MOD 6970

Aluminium	Roh	A	
166970-010-50-00		10	L = 5 m
Aluminium	Gebürstet		
OUTDOOR			
166970-010-50-18		10	L = 5 m

PREFIX

Für Smart **Seiten-**
montage- und Y-Profile

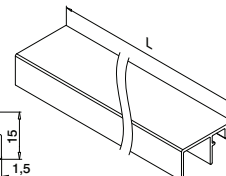
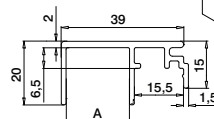

MOD 6970

Aluminium	Roh	A	
166970-020-50-00		20	L = 5 m
Aluminium	Gebürstet		
OUTDOOR			
166970-020-50-18		20	L = 5 m

PREFIX

Q-INFO MOD 6979

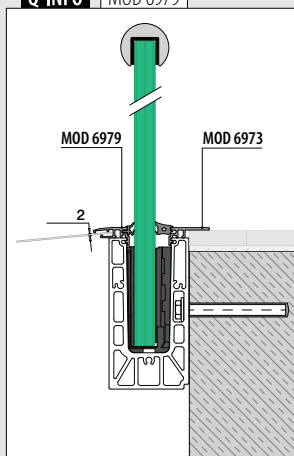

Q-INFO MOD 6972-010 / 6973

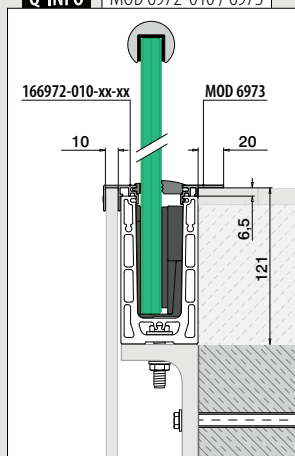

Q-INFO MOD 6972-020 / 6973

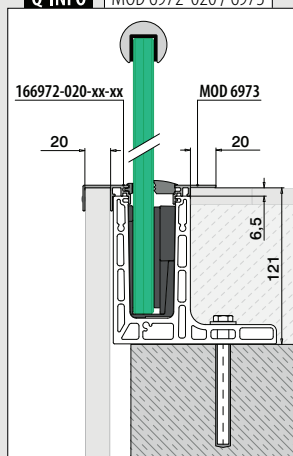

Q-INFO MOD 6970-010 / 6973

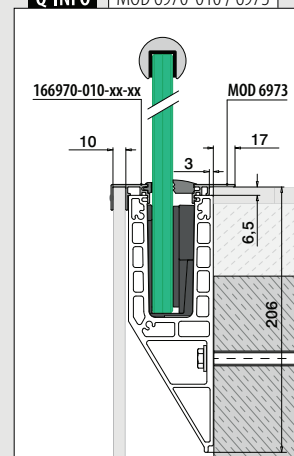



KANTEN-SCHUTZ

▣ 166



U-PROFILE

▣ 167, 168

GLASLEISTEN-ROHRE quadratisch / rechteckig

▣ 176



GLASLEISTEN-ROHRE rund

▣ 169



Q-railing

Kantenschutz

Kantenschutzprofile

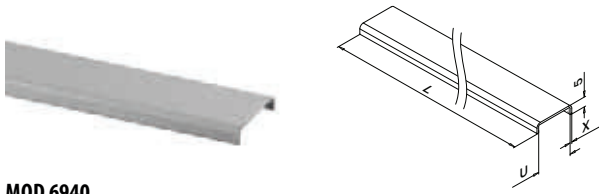

MOD 6940

Aluminium Roh	U	Q	X	T	Icon
166940-050-18-00	18,5	Q-98	1,5	16,76 - 17,52	L = 5 m
Aluminium Gebürstet					
OUTDOOR					
166940-025-18-18	18,5	Q-98	1,5	16,76 - 17,52	L = 2,5 m
166940-025-22-18	22,5	Q-99	1,5	20,76 - 21,52	L = 2,5 m
166940-050-18-18	18,5	Q-98	1,5	16,76 - 17,52	L = 5 m
166940-050-22-18	22,5	Q-99	1,5	20,76 - 21,52	L = 5 m
Aluminium Black Line					
OUTDOOR					
166940-025-18-82	18,5	Q-98	1,5	16,76 - 17,52	L = 2,5 m

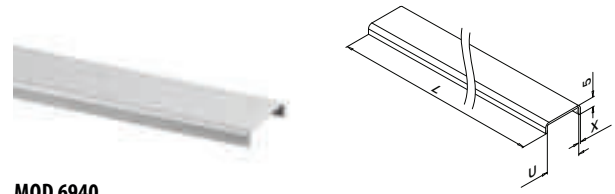

MOD 6940

V4A 316 Gebürstet	U	Q	X	T	Icon
OUTDOOR					
146940-025-18-12	18,5	Q-98	1	16,76 - 17,52	L = 2,5 m
146940-025-22-12	22,5	Q-99	1	20,76 - 21,52	L = 2,5 m
146940-050-14-12	14,5	Q-111	1	12,76 - 13,52	L = 5 m
146940-050-18-12	18,5	Q-98	1	16,76 - 17,52	L = 5 m
146940-050-22-12	22,5	Q-99	1	20,76 - 21,52	L = 5 m
146940-050-26-12	26,5	Q-112	1	24,76 - 25,52	L = 5 m



Kantenschutz

Ecken

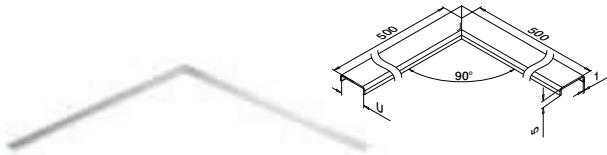

MOD 6340

V4A 316 Gebürstet	U	T	Icon
OUTDOOR			
146340-500-18	18,5	16,76 - 17,52	1
146340-500-22	22,5	20,76 - 21,52	1
146340-500-26	26,5	24,76 - 25,52	1

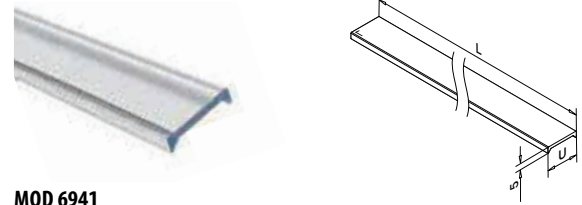

MOD 6941

Kunststoff Transparent	U	Q	T	Icon
INDOOR				
156941-025-18-03	18,5	Q-122	16,76 - 17,52	L = 2,5 m

NEW

Q-INFO Aluminium MOD 6940

00 Roh	18 Gebürstet, anodisiert	82 RAL 9005 Pulverbeschichtet Schwarz, matt, strukturiert
------------------	------------------------------------	--

Q-INFO

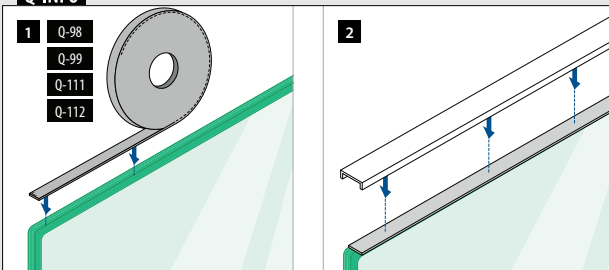

Q-INFO MOD 6940

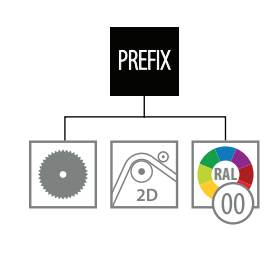

Q-INFO 316 MOD 6340 / 6940

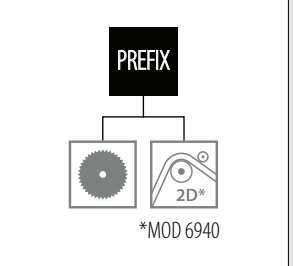

Q-INFO

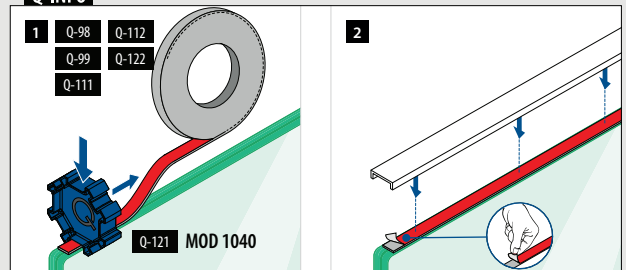

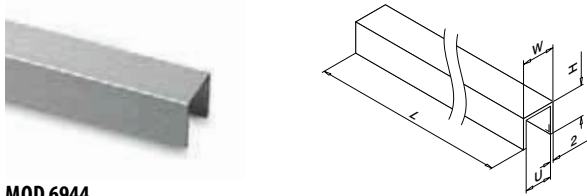

MOD 6944

Aluminium Gebürstet

OUTDOOR	U	Q	T	W	H	
166944-050-13-18	13,25	Q-111	12,76	17,25	15	L = 5 m
166944-050-18-18	18	Q-98	16,76 - 17,52	22	20	L = 5 m
166944-050-22-18	22	Q-99	21,52	26	20	L = 5 m

Aluminium Black Line

OUTDOOR	U	Q	T	W	H	
166944-050-13-82	13,25	Q-111	12,76	17,25	15	L = 5 m
166944-050-18-82	18	Q-98	16,76 - 17,52	22	20	L = 5 m
166944-050-22-82	22	Q-99	21,52	26	20	L = 5 m

NEW

NEW

NEW

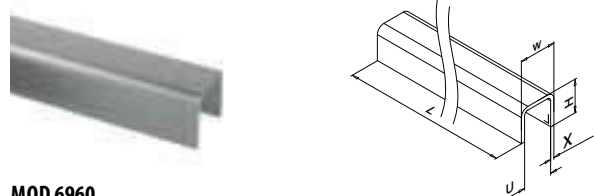

MOD 6960

V2A 304 Gebürstet

INDOOR	U	X	T	W	H	
136960-050-24-12	24	3	8 - 21,52	30	27	L = 5 m

V4A 316 Gebürstet

OUTDOOR	U	X	T	W	H	
146960-050-24-12	24	3	8 - 21,52	30	27	L = 5 m
146960-050-34-12	34	3	8 - 31,52	40	37	L = 5 m

V4A 316 Black Line

OUTDOOR	U	X	T	W	H	
146960-050-24-82	24	3	8 - 21,52	30	27	L = 5 m

MOD 6961

V2A 304 Gebürstet

INDOOR	U	X	T	W	H	
136961-050-24-12	24	2	8 - 21,52	28	26	L = 5 m

V4A 316 Gebürstet

OUTDOOR	U	X	T	W	H	
146961-050-24-12	24	2	8 - 21,52	28	26	L = 5 m
146961-050-34-12	34	2	8 - 31,52	38	36	L = 5 m



Q-INFO MOD 6944



Q-INFO Aluminium



Gebürstet, anodisiert
Schwarz, matt, strukturiert

Q-INFO MOD 6960 / 6961

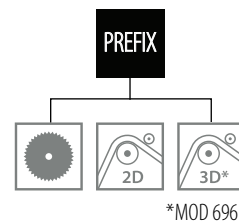

*MOD 6961

Q-INFO 304 316

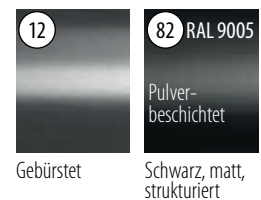

Gebürstet
Schwarz, matt, strukturiert

Q-INFO

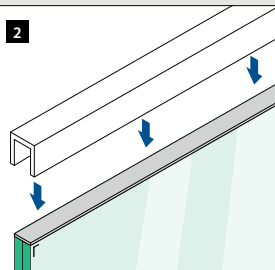
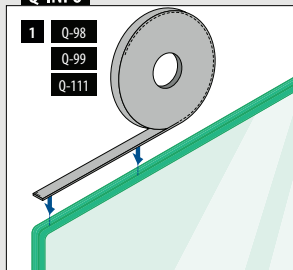

Q-INFO MOD 6960 / 6961

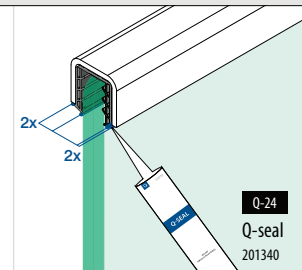
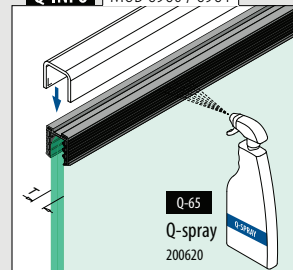

U-Profile

Ecken

Quadratisch



MOD 6362

V4A	316	Gebürstet	OUTDOOR	U	X	T	W	H		
				146362-24-12	24	3	8 - 21,52	30	27	1
				146362-34-12	34	3	8 - 31,52	40	37	1

V4A	316	Black Line	OUTDOOR	U	X	T	W	H		
NEW				146362-24-82	24	3	8 - 21,52	30	27	1

MOD 6361

V4A	316	Gebürstet	OUTDOOR	U	X	T	W	H		
				146361-24	24	2	8 - 21,52	28	26	1
				146361-34	34	2	8 - 31,52	38	36	1

U-Profile

Endkappen

Quadratisch

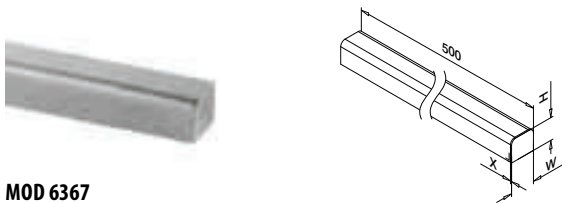

MOD 6367

V4A	316	Gebürstet	OUTDOOR	U	X	T	W	H		
				146367-24-12	24	3	8 - 21,52	30	27	1
				146367-34-12	34	3	8 - 31,52	40	37	1

V4A	316	Black Line	OUTDOOR	U	X	T	W	H		
NEW				146367-24-82	24	3	8 - 21,52	30	27	1

MOD 6366

V4A	316	Gebürstet	OUTDOOR	U	X	T	W	H		
				146366-24	24	2	8 - 21,52	28	26	1
				146366-34	34	2	8 - 31,52	38	36	1

U-Profile

Gummieinlagen



MOD 5124

Zubehör

U = 24 mm

Für monolithisches Glas	T	
205124-050-08	8 - 10	L = 5 m
205124-050-11	12	L = 5 m
205124-050-15	15	L = 5 m
205124-050-19	19	L = 5 m

Für laminiertes Glas

205124-050-08	8,76 - 10,76	L = 5 m
205124-050-11	11,52 - 13,52	L = 5 m
205124-050-17	16,76 - 17,52	L = 5 m
NEW 205124-050-92	20,76 - 21,52	L = 5 m

MOD 5134

Zubehör

U = 34 mm

Für monolithisches Glas	T	
205134-050-08	8 - 10	L = 5 m
205134-050-11	12	L = 5 m
205134-050-19	19	L = 5 m

Für laminiertes Glas

205134-050-08	8,76 - 10,76	L = 5 m
205134-050-11	11,52 - 13,52	L = 5 m
205134-050-17	16,76 - 17,52	L = 5 m
205134-050-22	20,76 - 21,52	L = 5 m
205134-050-24	24,76 - 25,52	L = 5 m
205134-050-32	31,52	L = 5 m

Q-INFO 304 316

12

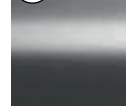

Gebürstet

82



Schwarz, matt, strukturiert

Q-INFO MOD 6366 / 6367

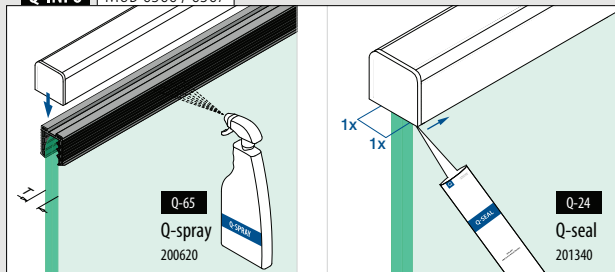

Q-INFO MOD 6361 / 6362

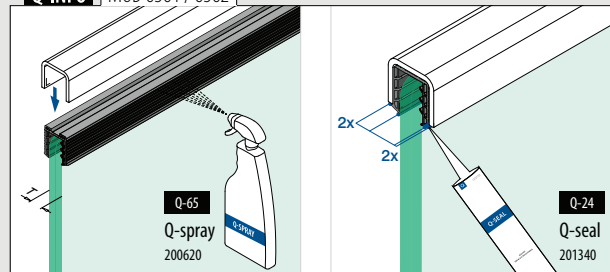

Glasleistenrohre

Glasleistenrohre

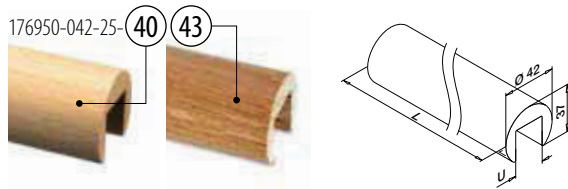

MOD 6950

Buche	Natur lackiert		
INDOOR	U		
176950-042-25-40	24		L = 2,5 m
Eiche	Natur lackiert		
INDOOR			
176950-042-25-43	24		L = 2,5 m

PREFIX

Glasleistenrohre

Verbinder



MOD 6791

V2A	304	Gebürstet		
INDOOR	Ø			
176791-042	42,0	QS-49 473		2



Glasleistenrohre

Endkappen



MOD 6729

V2A	304	Gebürstet		
INDOOR				
176729-042		QS-49 473		2



Holz ist ein Naturprodukt. Farbabweichungen sind möglich.

Glasleistenrohre

Gummieinlagen



MOD 5124

Zubehör		
U = 24 mm		
Für monolithisches Glas	T	
205124-050-08	8 - 10	L = 5 m
205124-050-11	12	L = 5 m
205124-050-15	15	L = 5 m
205124-050-19	19	L = 5 m

Für laminiertes Glas

205124-050-08	8,76 - 10,76	L = 5 m
205124-050-11	11,52 - 13,52	L = 5 m
205124-050-17	16,76 - 17,52	L = 5 m
NEW 205124-050-92	20,76 - 21,52	L = 5 m

Zubehör

Bohrschablone



MOD 1024

Zubehör	Q	
201024-042	Q-20	1

Q-INFO MOD 6950

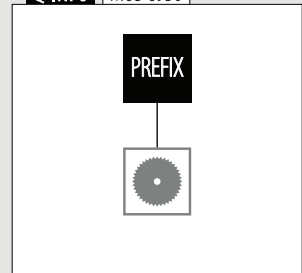

Q-INFO MOD 6950

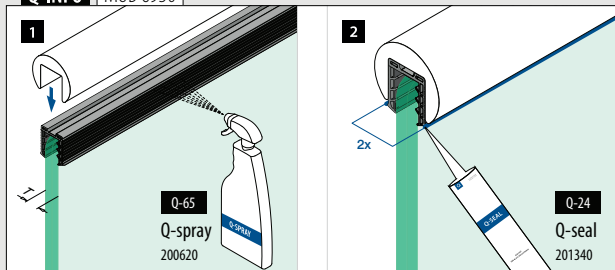

Q-INFO MOD 6729 / 1024

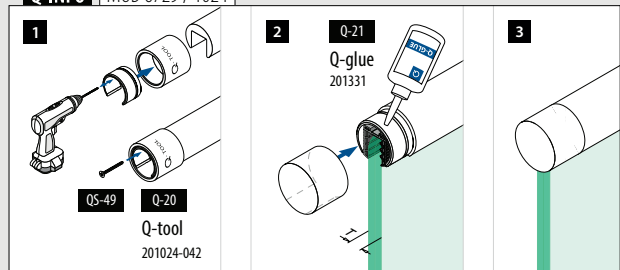

Glasleistenrohre

Glasleistenrohre

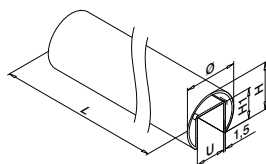
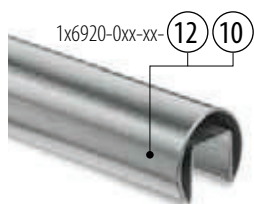

MOD 6920

Ø 42,4 mm

V2A	304	Gebürstet				
INDOOR			U	H	H1	
SELL OUT	136920-042-25-12		24	37	24	L = 2,5 m
	136920-042-50-12		24	37	24	L = 5 m

V4A	316	Gebürstet				
OUTDOOR						
	146920-042-50-12		24	37	24	L = 5 m

V4A	316	Hochglanzpoliert				
OUTDOOR						
	146920-042-50-10		24	37	24	L = 5 m

Ø 48,3 mm

V2A	304	Gebürstet				
INDOOR			U	H	H1	
	136920-048-50-12		27	42,6	30	L = 5 m

V4A	316	Gebürstet				
OUTDOOR						
	146920-048-50-12		27	42,6	30	L = 5 m

Ø 60,3 mm

V2A	304	Gebürstet				
INDOOR			U	H	H1	
	136920-060-50-12		34	53	34	L = 5 m

V4A	316	Gebürstet				
OUTDOOR						
	146920-060-50-12		34	53	34	L = 5 m



Glasleistenrohre

Gummieinlagen

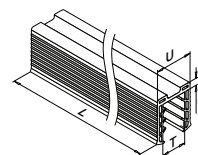

MOD 5124

Zubehör

U = 24 mm

Für monolithisches Glas	T	
205124-050-08	8 - 10	L = 5 m
205124-050-11	12	L = 5 m
205124-050-15	15	L = 5 m
205124-050-19	19	L = 5 m

205124-250-08	8 - 10	L = 25 m
205124-250-11	12	L = 25 m
205124-250-15	15	L = 25 m
205124-250-19	19	L = 25 m

Für laminiertes Glas

205124-050-08	8,76 - 10,76	L = 5 m
205124-050-11	11,52 - 13,52	L = 5 m
205124-050-17	16,76 - 17,52	L = 5 m
NEW 205124-050-92	20,76 - 21,52	L = 5 m

205124-250-08	8,76 - 10,76	L = 25 m
205124-250-11	11,52 - 13,52	L = 25 m
205124-250-17	16,76 - 17,52	L = 25 m
NEW 205124-250-92	20,76 - 21,52	L = 25 m

MOD 5127

Zubehör

U = 27 mm

Für monolithisches Glas	T	
205127-050-08	8 - 10	L = 5 m
205127-050-11	12	L = 5 m
205127-050-15	15	L = 5 m
205127-050-19	19	L = 5 m

Für laminiertes Glas

205127-050-08	8,76 - 10,76	L = 5 m
205127-050-11	11,52 - 13,52	L = 5 m
205127-050-15	16,76 - 17,52	L = 5 m
205127-050-22	20,76 - 21,52	L = 5 m
205127-050-24	24,76 - 25,52	L = 5 m

MOD 5134

Zubehör

U = 34 mm

Für monolithisches Glas	T	
205134-050-08	8 - 10	L = 5 m
205134-050-11	12	L = 5 m
205134-050-19	15	L = 5 m

Für laminiertes Glas

205134-050-08	8,76 - 10,76	L = 5 m
205134-050-11	11,52 - 13,52	L = 5 m
205134-050-17	16,76 - 17,52	L = 5 m
205134-050-22	20,76 - 21,52	L = 5 m
205134-050-24	24,76 - 25,52	L = 5 m
205134-050-32	31,52	L = 5 m

Q-INFO MOD 6920

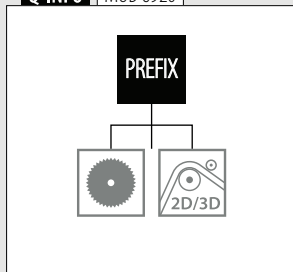

Q-INFO 316



SELL
OUT Nur solange der Vorrat reicht.

Verbinder

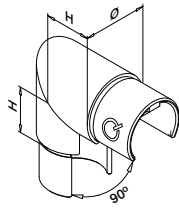

MOD 6303

V2A	304	Gebürstet			
INDOOR		Ø	H	☐	
	136303-042-12	42,4 x 1,5	30	2	
V4A	316	Gebürstet			
OUTDOOR					
	146303-042-12	42,4 x 1,5	30	2	

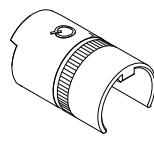
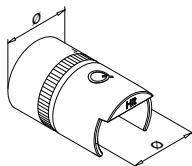

MOD 6792 - EASY HIT®

V2A	304	Roh			
INDOOR		Für Rohr Ø	☐		
	136792-042	42,4 x 1,5	2		
	136792-048	48,3 x 1,5	2		
V4A	316	Roh			
OUTDOOR					
	146792-042	42,4 x 1,5	2		
	146792-048	48,3 x 1,5	2		
	146792-060	60,3 x 1,5	2		

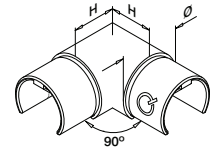

MOD 6313

V2A	304	Gebürstet			
INDOOR		Ø	H	☐	
	136313-042-12	42,4 x 1,5	30	2	
	136313-048-12	48,3 x 1,5	35	2	
SELL OUT	136313-060-12	60,3 x 1,5	40	2	
V4A	316	Gebürstet			
OUTDOOR					
	146313-042-12	42,4 x 1,5	30	2	
	146313-048-12	48,3 x 1,5	35	2	
	146313-060-12	60,3 x 1,5	40	2	
V4A	316	Hochglanzpoliert			
OUTDOOR					
	146313-042-10	42,4 x 1,5	30	2	

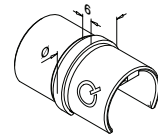

MOD 6790

V2A	304	Gebürstet			
INDOOR		Für Rohr Ø	☐		
	136790-042-12	42,4 x 1,5	2		
	136790-048-12	48,3 x 1,5	2		
SELL OUT	136790-060-12	60,3 x 1,5	2		
V4A	316	Gebürstet			
OUTDOOR					
	146790-042-12	42,4 x 1,5	2		
	146790-048-12	48,3 x 1,5	2		
V4A	316	Hochglanzpoliert			
OUTDOOR					
	146790-042-10	42,4 x 1,5	2		



Q-INFO | MOD 6792

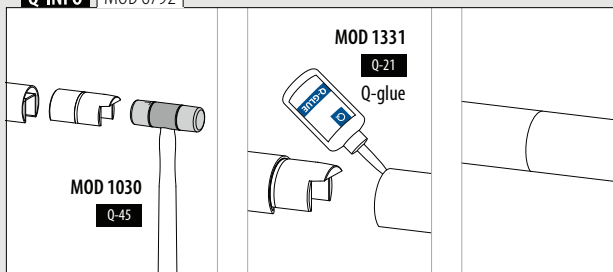



25–55°
Abwärts

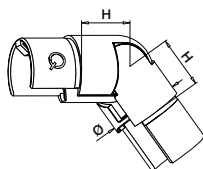

25–55°
Aufwärts

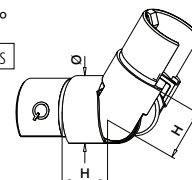

MOD 6302

V2A	304	Gebürstet			
INDOOR			Ø	H	☐
	136302-042-02-12		42,4 x 1,5	30	2
	136302-048-02-12		48,3 x 1,5	35	2
SELL OUT	136302-060-02-12		60,3 x 1,5	40	2
V4A	316	Gebürstet			
OUTDOOR			Ø	H	☐
	146302-042-02-12		42,4 x 1,5	30	2
	146302-048-02-12		48,3 x 1,5	35	2
	146302-060-02-12		60,3 x 1,5	40	2
V4A	316	Hochglanzpoliert			
OUTDOOR			Ø	H	☐
	146302-042-02-10		42,4 x 1,5	30	2



MOD 6302

V2A	304	Gebürstet			
INDOOR			Ø	H	☐
	136302-042-01-12		42,4 x 1,5	30	2
	136302-048-01-12		48,3 x 1,5	35	2
SELL OUT	136302-060-01-12		60,3 x 1,5	40	2
V4A	316	Gebürstet			
OUTDOOR			Ø	H	☐
	146302-042-01-12		42,4 x 1,5	30	2
	146302-048-01-12		48,3 x 1,5	35	2
	146302-060-01-12		60,3 x 1,5	40	2
V4A	316	Hochglanzpoliert			
OUTDOOR			Ø	H	☐
	146302-042-01-10		42,4 x 1,5	30	2



+40° / -95°
Horizontal

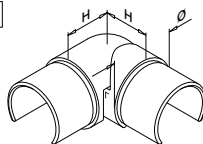

MOD 6312

V2A	304	Gebürstet			
INDOOR			Ø	H	☐
	136312-042-12		42,4 x 1,5	27	2
	136312-048-12		48,3 x 1,5	30	2
V4A	316	Gebürstet			
OUTDOOR			Ø	H	☐
	146312-042-12		42,4 x 1,5	27	2
	146312-048-12		48,3 x 1,5	30	2

NEW



Q-INFO 316

10

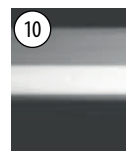

Hochglanzpoliert

12



Gebürstet

SELL OUT

Nur solange der Vorrat reicht.

Glasleistenrohr/Rohr-Verbinder

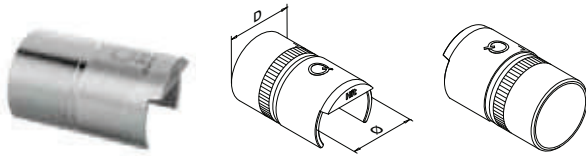

MOD 5793 - EASY HIT®

V4A	316	Roh	OUTDOOR	Für Rohr D	Für Rohr Ø	☐
			145793-042	42,4 x 2,0	42,4 x 1,5	2
			145793-048	48,3 x 2,0	48,3 x 1,5	2



Internationaler Geschmacksmusterschutz

Endbögen



MOD 6738

V2A	304	Gebürstet	INDOOR	Für Rohr Ø	L	☐
			136738-042-12	42,4 x 1,5	60	2
			136738-048-12	48,3 x 1,5	65	2

V4A	316	Gebürstet	OUTDOOR	Für Rohr Ø	L	☐
			146738-042-12	42,4 x 1,5	60	2



Internationaler Geschmacksmusterschutz

Endkappen



MOD 6732

V2A	304	Gebürstet	INDOOR	Für Rohr Ø	☐
			136732-042-12	42,4 x 1,5	2
			136732-048-12	48,3 x 1,5	2
SELL OUT			136732-060-12	60,3 x 1,5	2

V4A	316	Gebürstet	OUTDOOR	Für Rohr Ø	☐
			146732-042-12	42,4 x 1,5	2
			146732-048-12	48,3 x 1,5	2
			146732-060-12	60,3 x 1,5	2

V4A	316	Hochglanzpoliert	OUTDOOR	Für Rohr Ø	☐
			146732-042-10	42,4 x 1,5	2



Wandflansche

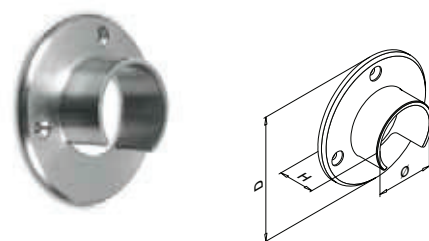

MOD 6505

V2A	304	Gebürstet	INDOOR	Für Ø	D	H	☐
			136505-042-12	42,4	90	30	QS-5 473 2
			136505-048-12	48,3	95	35	QS-5 473 2
SELL OUT			136505-060-12	60,3	107	35	QS-5 473 2

V4A	316	Gebürstet	OUTDOOR	Für Ø	D	H	☐
			146505-042-12	42,4	90	30	QS-6 473 2
			146505-048-12	48,3	95	35	QS-6 473 2
			146505-060-12	60,3	107	35	QS-6 473 2

V4A	316	Hochglanzpoliert	OUTDOOR	Für Ø	D	H	☐
			146505-042-10	42,4	90	30	QS-6 473 2



Q-INFO MOD 6738

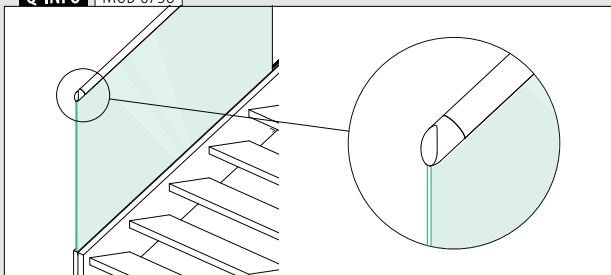

Q-INFO MOD 5793

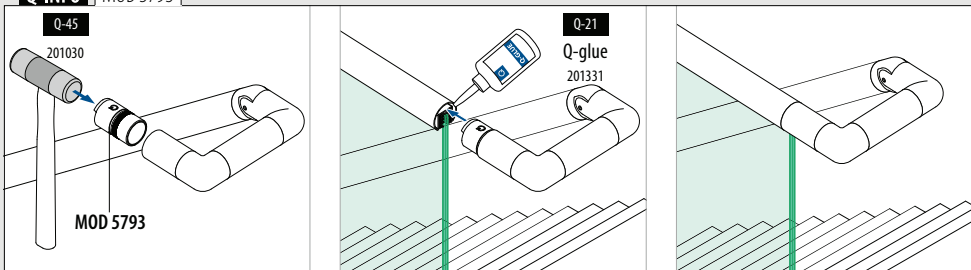

Glasleistenrohre

Glasleistenrohre

166920-042-50-00 18

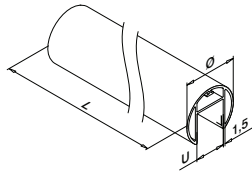

MOD 6920

Aluminium	Roh	U	Ø	
166920-042-50-00		24	42,4	L = 5 m
Aluminium	Gebürstet			
OUTDOOR				
166920-042-50-18		24	42,4	L = 5 m



Internationaler Geschmacksmusterschutz

Glasleistenrohre

Ecken

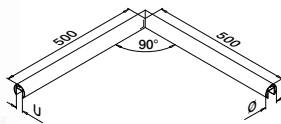

MOD 6320

Aluminium	Roh	U	Ø	
166320-042-00		24	42,4 x 1,5	1
Aluminium	Gebürstet			
OUTDOOR				
166320-042-18		24	42,4 x 1,5	1

Internationaler Geschmacksmusterschutz

Glasleistenrohre

Endkappen

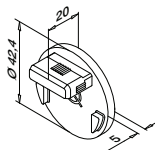

MOD 6732 - EASY HIT®

Aluminium	Roh	Für Ø	
166732-042-00		42,4 x 1,5	2
Aluminium	Gebürstet		
OUTDOOR			
166732-042-18		42,4 x 1,5	2



Internationaler Geschmacksmusterschutz

Glasleistenrohre

Gummieinlagen

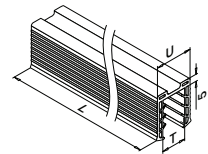

MOD 5124

Zubehör

U = 24 mm

Für monolithisches Glas	T	
205124-050-08	8 - 10	L = 5 m
205124-050-11	12	L = 5 m
205124-050-15	15	L = 5 m
205124-050-19	19	L = 5 m
<hr/>		
205124-250-08	8 - 10	L = 25 m
205124-250-11	12	L = 25 m
205124-250-15	15	L = 25 m
205124-250-19	19	L = 25 m

Für laminiertes Glas

205124-050-08	8,76 - 10,76	L = 5 m
205124-050-11	11,52 - 13,52	L = 5 m
205124-050-17	16,76 - 17,52	L = 5 m
NEW 205124-050-92	20,76 - 21,52	L = 5 m
<hr/>		
205124-250-08	8,76 - 10,76	L = 25 m
205124-250-11	11,52 - 13,52	L = 25 m
205124-250-17	16,76 - 17,52	L = 25 m
NEW 205124-250-92	20,76 - 21,52	L = 25 m

Q-INFO MOD 6920

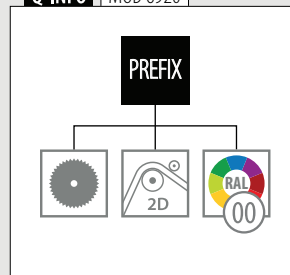

Q-INFO Aluminium



Q-INFO MOD 6920 / 5124 / 6732

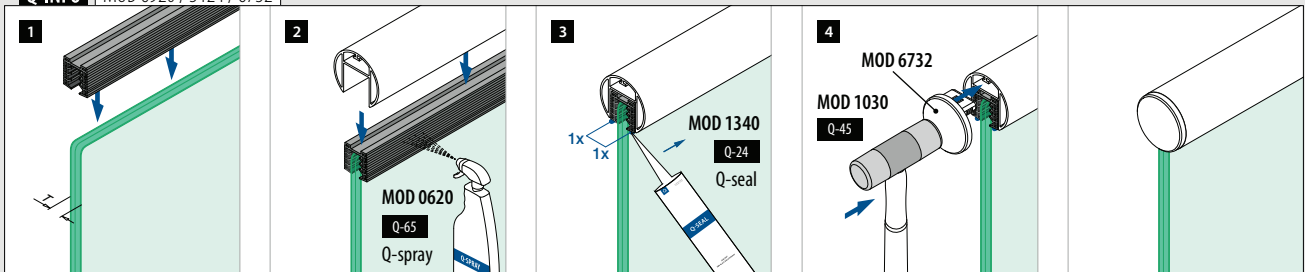

Verbinder

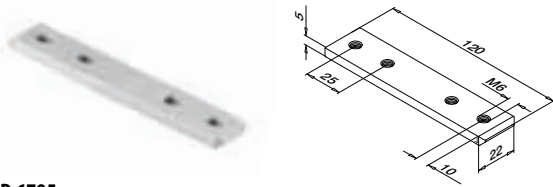

MOD 6795

Aluminium	Roh		
166795-339	QS-261	474	2



MOD 6311

Aluminium	Roh		
166311-339	QS-261	474	2

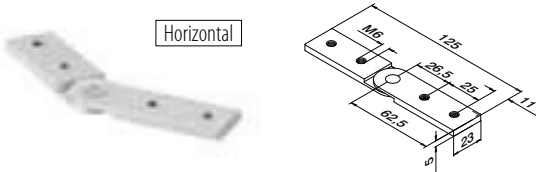

MOD 6797

Aluminium	Roh		
166797	QS-261	474	2

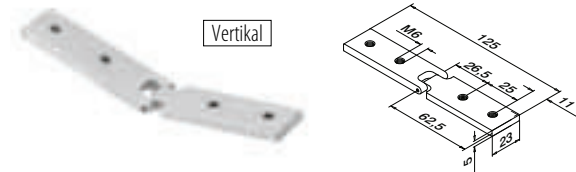

MOD 6798

Aluminium	Roh		
166798	QS-261	474	2

Q-INFO MOD 6311

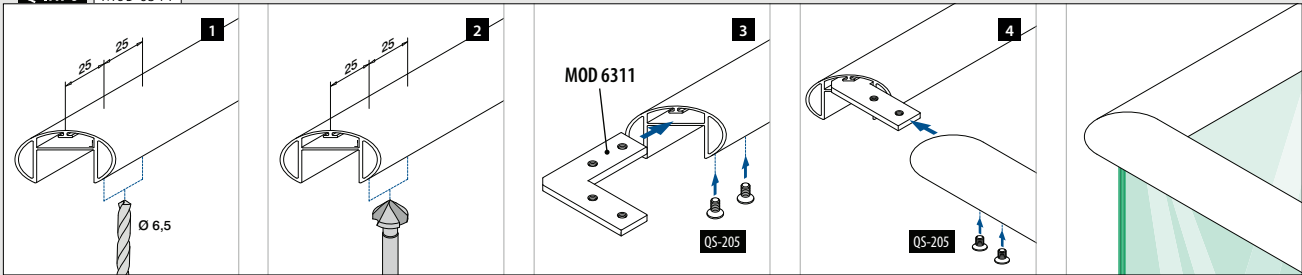

Q-INFO MOD 6797

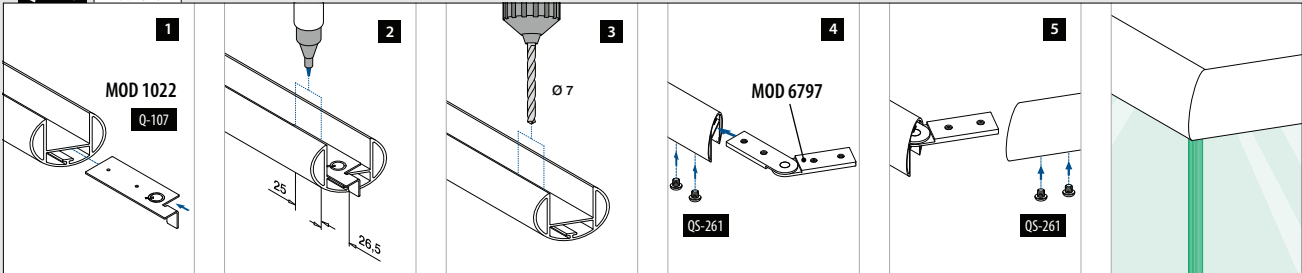

Q-INFO MOD 6798

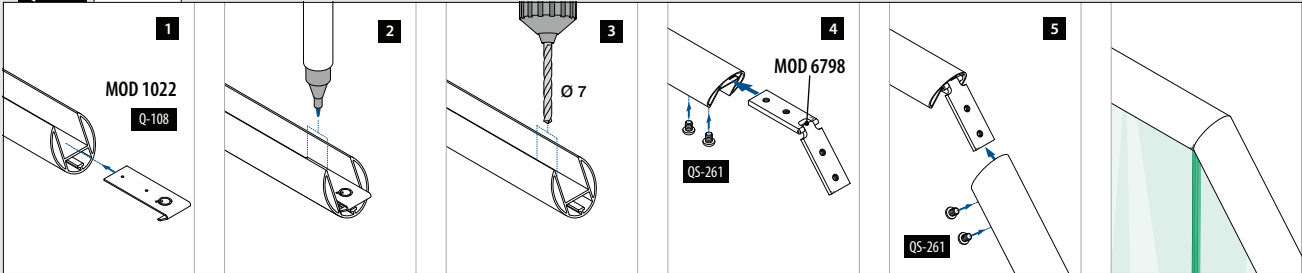

Q-INFO MOD 6798

Nach oben

Schneiden	45°	40°	35°	30°	25°	20°	15°	10°	5°	0°
Außenwinkel	90°	100°	110°	120°	130°	140°	150°	160°	170°	180°
Abstand zum Rand (x)	30,5	30,0	29,5	29,0	28,5	28,0	27,5	27,0	27,0	26,5

Nach unten

Schneiden	0°	5°	10°	15°	20°	25°	30°	35°	40°	45°
Innenwinkel	180°	170°	160°	150°	140°	130°	120°	110°	100°	90°
Abstand zum Rand (x)	26,5	26,5	26,0	26,0	25,5	25,5	25,0	24,5	24,5	24,0

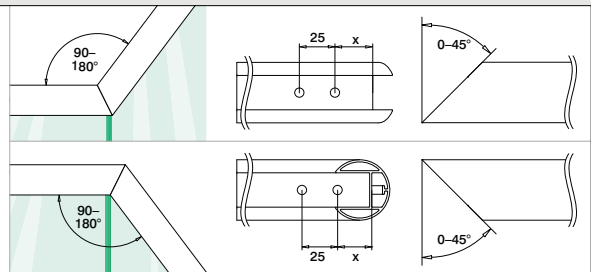

Glasleistenrohre

Glasleistenrohre

Quadratisch

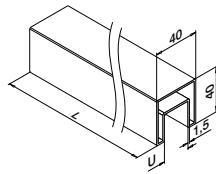

MOD 6924

V2A	304	Gebürstet		
INDOOR				
	U	<input type="checkbox"/>	<input type="checkbox"/>	
SELL OUT	136924-040-25-12	24	40 x 40	L = 2,5 m
	136924-040-50-12	24	40 x 40	L = 5 m
V4A	316	Gebürstet		
OUTDOOR				
	146924-040-25-12	24	40 x 40	L = 2,5 m
	146924-040-50-12	24	40 x 40	L = 5 m



Glasleistenrohre

Gummieinlagen

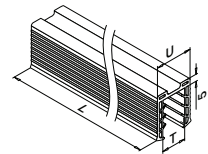

MOD 5124

Zubehör		
U = 24 mm		
Für monolithisches Glas		T
205124-050-08	8 - 10	L = 5 m
205124-050-11	12	L = 5 m
205124-050-15	15	L = 5 m
205124-050-19	19	L = 5 m
<hr/>		
205124-250-08	8 - 10	L = 25 m
205124-250-11	12	L = 25 m
205124-250-15	15	L = 25 m
205124-250-19	19	L = 25 m

Für laminiertes Glas		
205124-050-08	8,76 - 10,76	L = 5 m
205124-050-11	11,52 - 13,52	L = 5 m
205124-050-17	16,76 - 17,52	L = 5 m
NEW 205124-050-92	20,76 - 21,52	L = 5 m
<hr/>		
205124-250-08	8,76 - 10,76	L = 25 m
205124-250-11	11,52 - 13,52	L = 25 m
205124-250-17	16,76 - 17,52	L = 25 m
NEW 205124-250-92	20,76 - 21,52	L = 25 m

Q-INFO MOD 6924

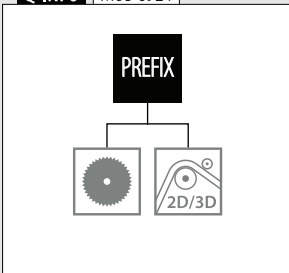

Q-INFO MOD 6924 / 5124 / 6734

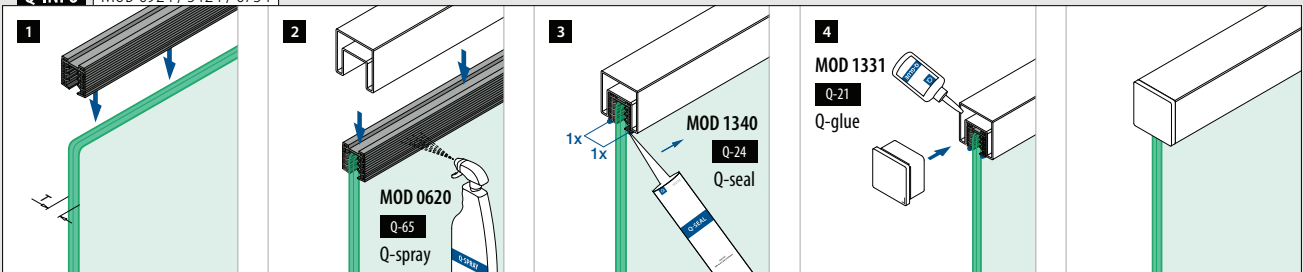

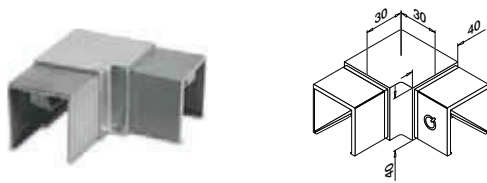

MOD 6343

V2A	304	Gebürstet		
INDOOR				
136343-040-12	40 x 40	2		
V4A	316	Gebürstet		
OUTDOOR				
146343-040-12	40 x 40	2		



MOD 6794

V2A	304	Gebürstet		
INDOOR				
136794-040-12	40 x 40	2		
V4A	316	Gebürstet		
OUTDOOR				
146794-040-12	40 x 40	2		

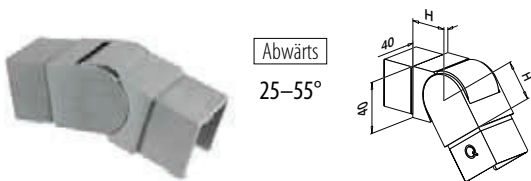

MOD 6342

V2A	304	Gebürstet		
INDOOR				
136342-040-02-12	40 x 40	30	2	
V4A	316	Gebürstet		
OUTDOOR				
146342-040-02-12	40 x 40	30	2	



MOD 6342

V2A	304	Gebürstet		
INDOOR				
136342-040-01-12	40 x 40	30	2	
V4A	316	Gebürstet		
OUTDOOR				
146342-040-01-12	40 x 40	30	2	

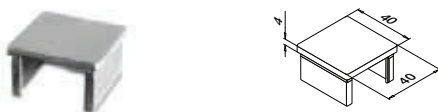

MOD 6734

V2A	304	Gebürstet		
INDOOR				
136734-040-12	40 x 40	2		
V4A	316	Gebürstet		
OUTDOOR				
146734-040-12	40 x 40	2		

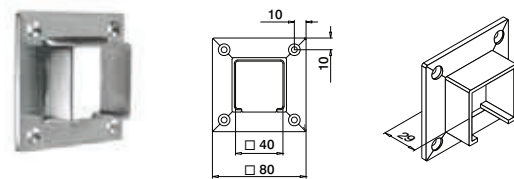

MOD 6545

V2A	304	Gebürstet		
INDOOR				
136545-040-12	40 x 40	QS-7 473	2	
V4A	316	Gebürstet		
OUTDOOR				
146545-040-12	40 x 40	QS-50 473	2	



Glasleistenrohre

Glasleistenrohre

Quadratisch

166924-040-50-00 18 82

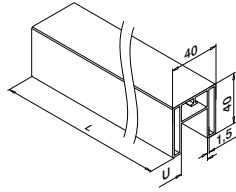
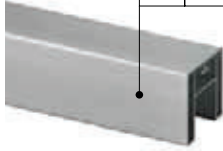

MOD 6924

Aluminium	Roh	U	□	⊞
166924-040-50-00		24	40 x 40	L = 5 m
Aluminium	Gebürstet			
OUTDOOR				
166924-040-50-18		24	40 x 40	L = 5 m
Aluminium	Black Line			
OUTDOOR				
NEW 166924-040-50-82		24	40 x 40	L = 5 m



Internationaler Geschmacksmusterschutz

Glasleistenrohre

Gummieinlagen

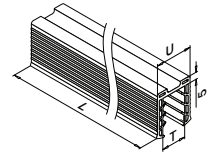

MOD 5124

Zubehör

U = 24 mm

Für monolithisches Glas	T	⊞
205124-050-08	8 - 10	L = 5 m
205124-050-11	12	L = 5 m
205124-050-15	15	L = 5 m
205124-050-19	19	L = 5 m

Für laminiertes Glas

205124-050-08	8,76 - 10,76	L = 5 m
205124-050-11	11,52 - 13,52	L = 5 m
205124-050-17	16,76 - 17,52	L = 5 m
NEW 205124-050-92	20,76 - 21,52	L = 5 m

Glasleistenrohre

Ecken

Quadratisch

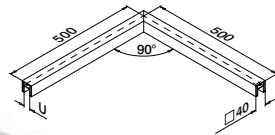

MOD 6324

Aluminium	Gebürstet	U	□	⊞
OUTDOOR				
166324-040-18		24	40 x 40 x 1,5	1
Aluminium	Black Line			
OUTDOOR				
NEW 166324-040-82		24	40 x 40 x 1,5	1

Glasleistenrohre

Endkappen

Quadratisch

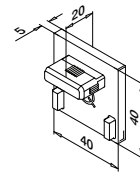

MOD 6734 - EASY HIT®

Aluminium	Roh	□	⊞
166734-040-00		40 x 40	2
Aluminium	Gebürstet		
OUTDOOR			
166734-040-18		40 x 40	2
Aluminium	Black Line		
OUTDOOR			
NEW 166734-040-82		40 x 40	2



Internationaler Geschmacksmusterschutz

Q-INFO Aluminium

00

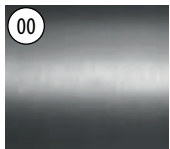

Roh

18

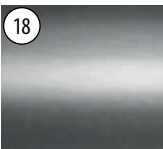

Gebürstet,
anodisiert

82



Schwarz, matt,
strukturiert

Q-INFO MOD 6924

PREFIX

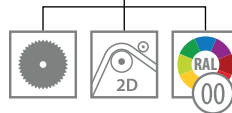

Q-INFO MOD 6924 / 5124 / 6734

1

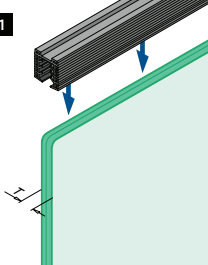

2

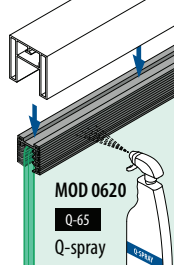

3

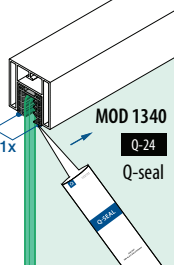

4

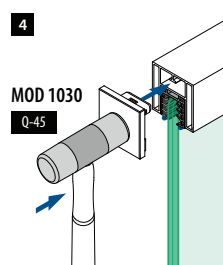

Verbinder

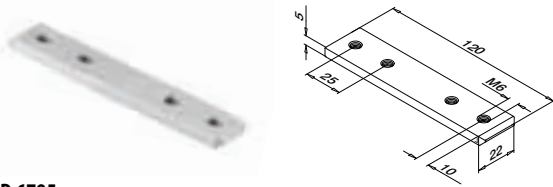

MOD 6795

Aluminium	Roh		
166795-339	QS-261	474	2

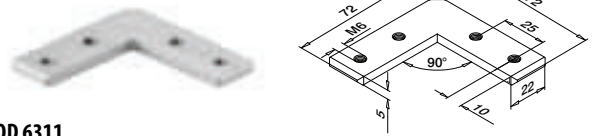

MOD 6311

Aluminium	Roh		
166311-339	QS-261	474	2

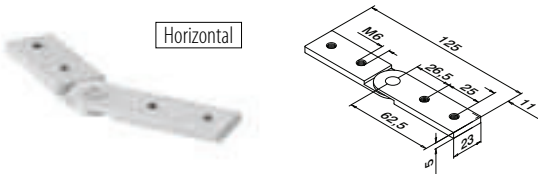

MOD 6797

Aluminium	Roh		
166797	QS-261	474	2

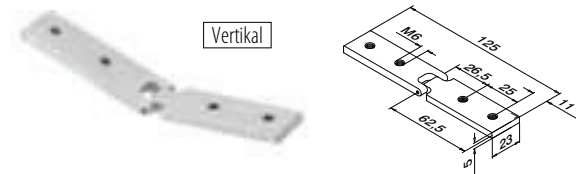

MOD 6798

Aluminium	Roh		
166798	QS-261	474	2

Q-INFO MOD 6311

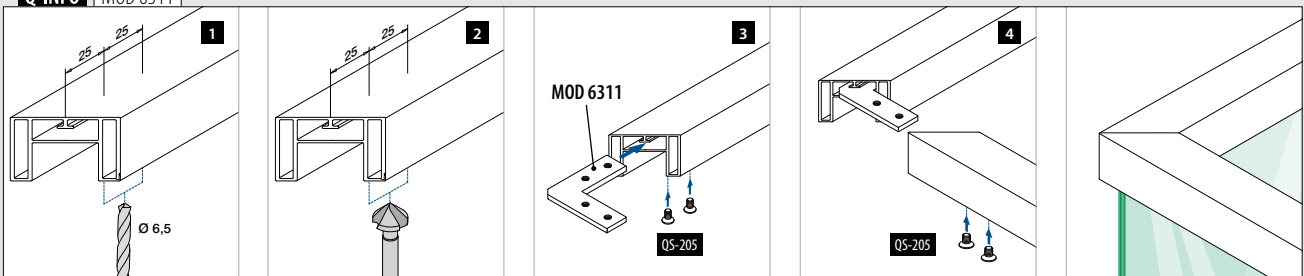

Q-INFO MOD 6797

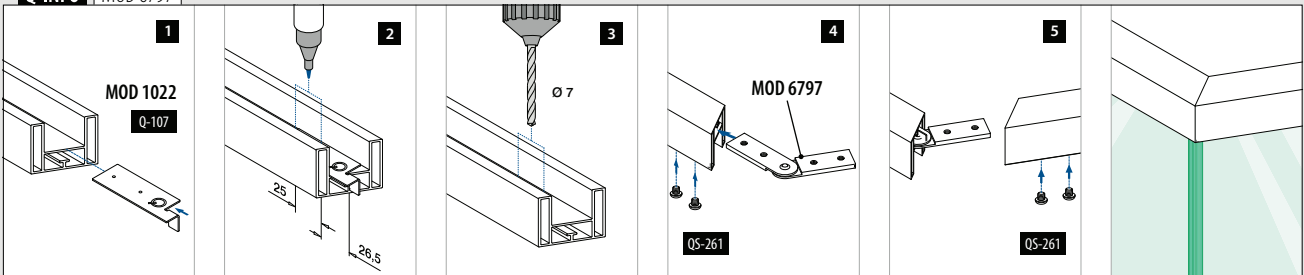

Q-INFO MOD 6798

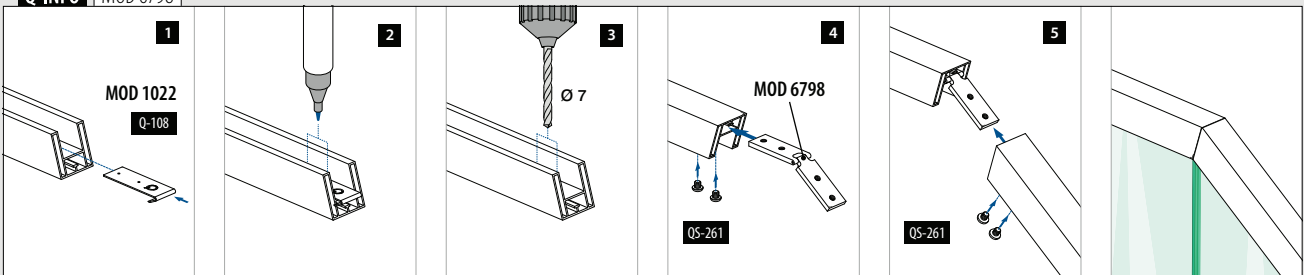

Q-INFO MOD 6798

Nach oben

Schneiden	45°	40°	35°	30°	25°	20°	15°	10°	5°	0°
Außenwinkel	90°	100°	110°	120°	130°	140°	150°	160°	170°	180°
Abstand zum Rand (x)	30,5	30,0	29,5	29,0	28,5	28,0	27,5	27,0	27,0	26,5

Nach unten

Schneiden	0°	5°	10°	15°	20°	25°	30°	35°	40°	45°
Innenwinkel	180°	170°	160°	150°	140°	130°	120°	110°	100°	90°
Abstand zum Rand (x)	26,5	26,5	26,0	26,0	25,5	25,5	25,0	24,5	24,5	24,0

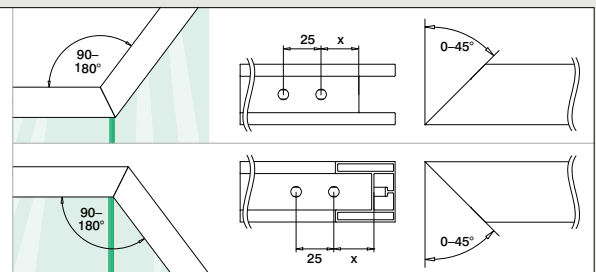



Glasleistenrohre

Glasleistenrohre

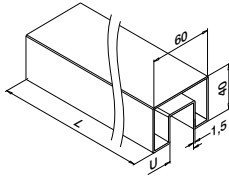
Rechteckig 



MOD 6924

V2A	304	Gebürstet		
INDOOR		U		
SELL OUT	136924-640-50-12	24	60 x 40	L = 5 m
V4A	316	Gebürstet		
OUTDOOR				
	146924-640-50-12	24	60 x 40	L = 5 m



Glasleistenrohre

Gummieinlagen

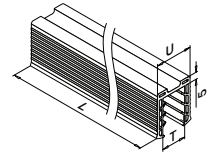

MOD 5124

Zubehör		
U = 24 mm		
Für monolithisches Glas	T	
205124-050-08	8 - 10	L = 5 m
205124-050-11	12	L = 5 m
205124-050-15	15	L = 5 m
205124-050-19	19	L = 5 m
<hr/>		
205124-250-08	8 - 10	L = 25 m
205124-250-11	12	L = 25 m
205124-250-15	15	L = 25 m
205124-250-19	19	L = 25 m

Für laminiertes Glas

205124-050-08	8,76 - 10,76	L = 5 m
205124-050-11	11,52 - 13,52	L = 5 m
205124-050-17	16,76 - 17,52	L = 5 m
NEW 205124-050-92	20,76 - 21,52	L = 5 m
<hr/>		
205124-250-08	8,76 - 10,76	L = 25 m
205124-250-11	11,52 - 13,52	L = 25 m
205124-250-17	16,76 - 17,52	L = 25 m
NEW 205124-250-92	20,76 - 21,52	L = 25 m

Q-INFO | MOD 6924

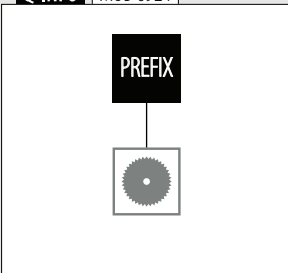

Q-INFO | MOD 6924 / 5124 / 6734

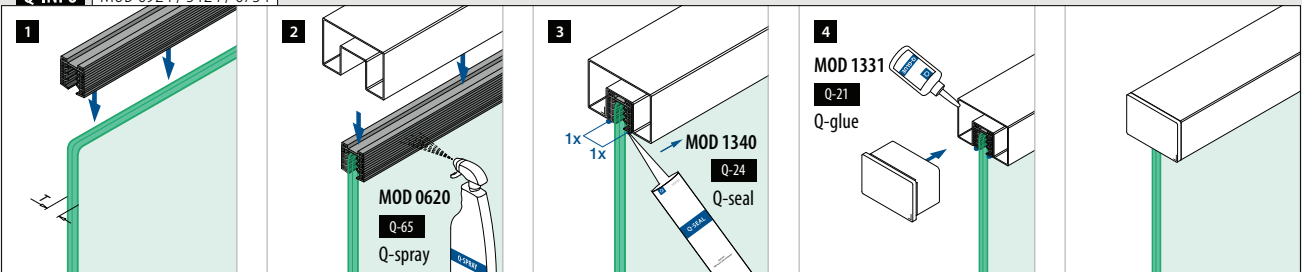

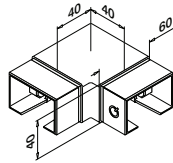

MOD 6343

V2A	304	Gebürstet		
	INDOOR	Für <input type="checkbox"/>		
SELL OUT	136343-640-12	60 x 40		2
V4A	316	Gebürstet		
	OUTDOOR			
	146343-640-12	60 x 40		2

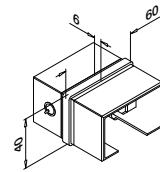

MOD 6794

V2A	304	Gebürstet		
	INDOOR	Für <input type="checkbox"/>		
SELL OUT	136794-640-12	60 x 40		2
V4A	316	Gebürstet		
	OUTDOOR			
	146794-640-12	60 x 40		2



25–55°
Abwärts

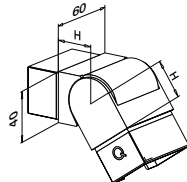

MOD 6342

V2A	304	Gebürstet		
	INDOOR	Für <input type="checkbox"/>	H	
SELL OUT	136342-640-02-12	60 x 40	30	2
V4A	316	Gebürstet		
	OUTDOOR			
	146342-640-02-12	60 x 40	30	2



25–55°
Aufwärts

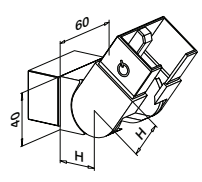

MOD 6342

V2A	304	Gebürstet		
	INDOOR	Für <input type="checkbox"/>	H	
SELL OUT	136342-640-01-12	60 x 40	30	2
V4A	316	Gebürstet		
	OUTDOOR			
	146342-640-01-12	60 x 40	30	2

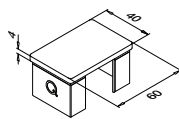

MOD 6734

V2A	304	Gebürstet		
	INDOOR	Für <input type="checkbox"/>		
SELL OUT	136734-640-12	60 x 40		2
V4A	316	Gebürstet		
	OUTDOOR			
	146734-640-12	60 x 40		2

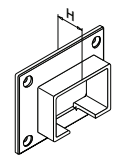
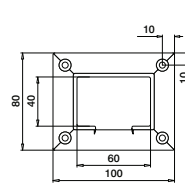

MOD 6545

V2A	304	Gebürstet		
	INDOOR	Für <input type="checkbox"/>	H	
SELL OUT	136545-640-12	60 x 40	29	QS-7 473
V4A	316	Gebürstet		
	OUTDOOR			
	146545-640-12	60 x 40	29	QS-50 473



Glasleistenrohre

Glasleistenrohre

Rechteckig

166924-654-50-00 08

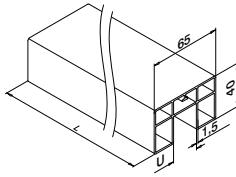
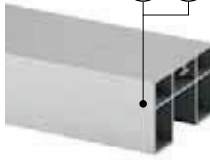

MOD 6924

Aluminium Roh

	U		
166924-654-50-00	24	65 x 40	L = 5 m

Aluminium Matt Silbereffekt

OUTDOOR

166924-654-50-08	24	65 x 40	L = 5 m
------------------	----	---------	---------



Internationaler Geschmacksmusterschutz

Glasleistenrohre

Endkappen

Rechteckig

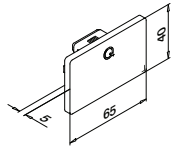

MOD 6734 - EASY HIT®

Aluminium Roh

	Für	
166734-654-00	65 x 40	2

Aluminium Matt Silbereffekt

OUTDOOR

166734-654-08	65 x 40	2
---------------	---------	---



Internationaler Geschmacksmusterschutz

Glasleistenrohre

Gummieinlagen

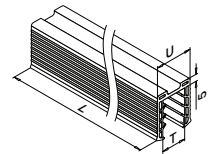

MOD 5124

Zubehör

U = 24 mm

Für monolithisches Glas	T	
205124-050-08	8 - 10	L = 5 m
205124-050-11	12	L = 5 m
205124-050-15	15	L = 5 m
205124-050-19	19	L = 5 m

Für laminiertes Glas

205124-050-08	8,76 - 10,76	L = 5 m
205124-050-11	11,52 - 13,52	L = 5 m
205124-050-17	16,76 - 17,52	L = 5 m
205124-050-92	20,76 - 21,52	L = 5 m

NEW

Glasleistenrohre

Wandflansche

Rechteckig

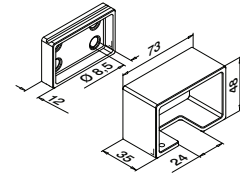

MOD 6545

Aluminium Roh

	Für		
166545-654-00	65 x 40	QS-55 472 / QS-20 474	2



Internationaler Geschmacksmusterschutz

SELL OUT Nur solange der Vorrat reicht.

Q-INFO MOD 6924

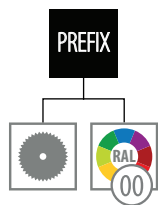

Q-INFO Aluminium

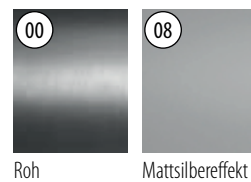

Q-INFO MOD 6924



Fügen Sie mithilfe des MOD 6926 Glasleistenrohres eine LED-Beleuchtung (Linear Light) hinzu

Q-INFO MOD 6924 / 5124 / 6734

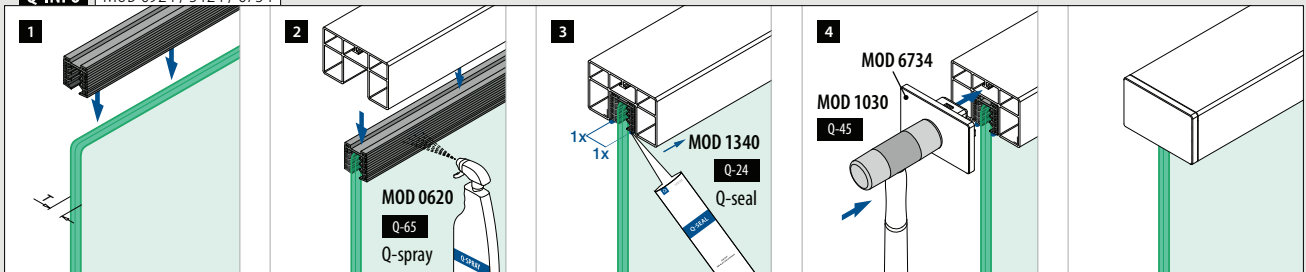

Verbinder

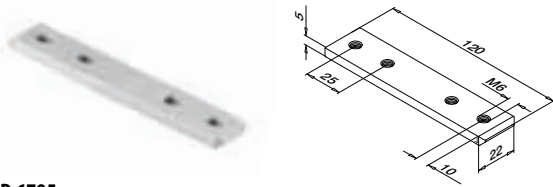

MOD 6795

Aluminium	Roh		
166795-339	QS-261	474	2



MOD 6311

Aluminium	Roh		
166311-339	QS-261	474	2

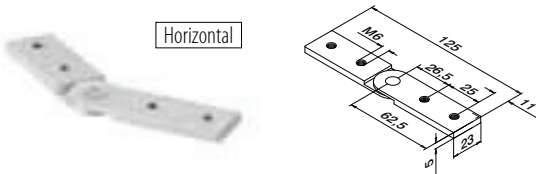

MOD 6797

Aluminium	Roh		
166797	QS-261	474	2

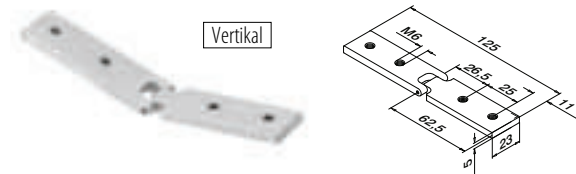

MOD 6798

Aluminium	Roh		
166798	QS-261	474	2

Q-INFO MOD 6311

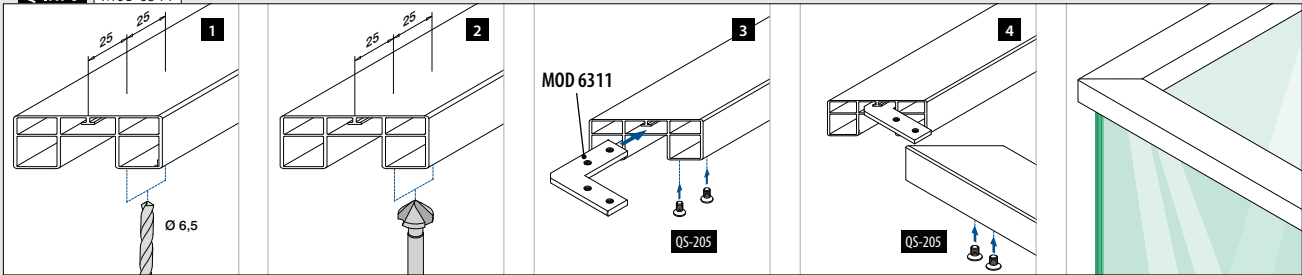

Q-INFO MOD 6797

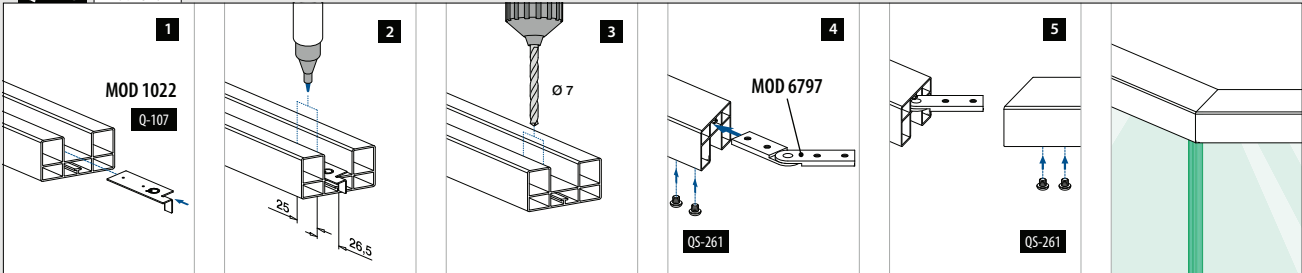

Q-INFO MOD 6798

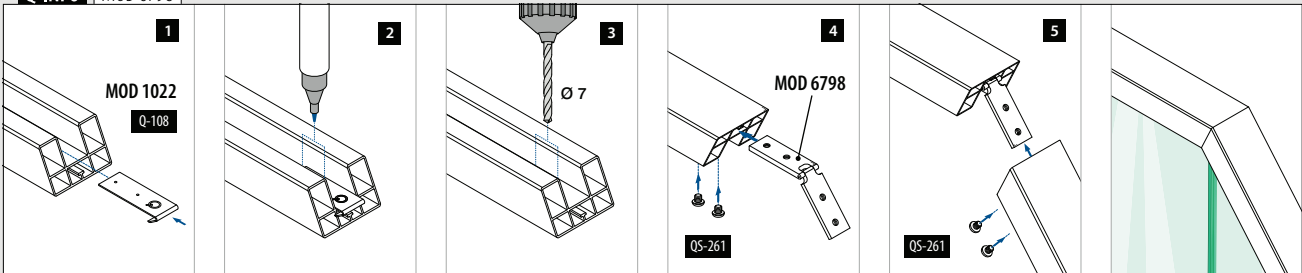

Q-INFO MOD 6798

Nach oben

Schneiden	45°	40°	35°	30°	25°	20°	15°	10°	5°	0°
Außenwinkel	90°	100°	110°	120°	130°	140°	150°	160°	170°	180°
Abstand zum Rand (x)	30,5	30,0	29,5	29,0	28,5	28,0	27,5	27,0	27,0	26,5

Nach unten

Schneiden	0°	5°	10°	15°	20°	25°	30°	35°	40°	45°
Innenwinkel	180°	170°	160°	150°	140°	130°	120°	110°	100°	90°
Abstand zum Rand (x)	26,5	26,5	26,0	26,0	25,5	25,5	25,0	24,5	24,5	24,0

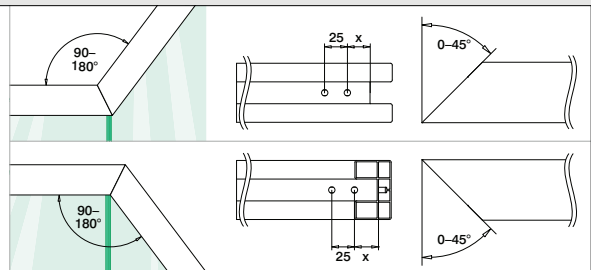

Glasleistenrohre

Glasleistenrohre

HYBRID 33x39

166911-339-50-00 08 18 82

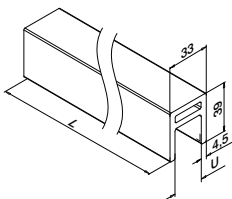
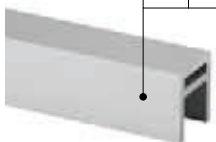

MOD 6911

Aluminium	Roh	U	
166911-339-50-00	24	L = 5 m	
Aluminium	Matt Silbereffekt	OUTDOOR	
166911-339-50-08	24	L = 5 m	
Aluminium	Gebürstet	OUTDOOR	
166911-339-50-18	24	L = 5 m	
Aluminium	Black Line	OUTDOOR	
166911-339-50-82	24	L = 5 m	



Internationaler Geschmacksmusterschutz

Glasleistenrohre

Gummieinlagen

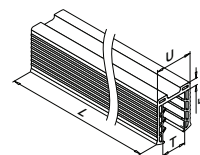

MOD 5124

Zubehör	U = 24 mm	
Für monolithisches Glas	T	
205124-050-08	8 - 10	L = 5 m
Für laminiertes Glas		
205124-050-08	8,76 - 10,76	L = 5 m
205124-050-11	11,52 - 13,52	L = 5 m

Glasleistenrohre

Wandflansche

HYBRID 33x39

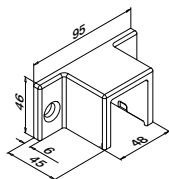

MOD 6515

V4A	316	Gebürstet		
	OUTDOOR			
146515-339-12	QS-214	470		2
V4A	316	Black Line		
	OUTDOOR			
146515-339-82	QS-214	470		2



Q-INFO Aluminium

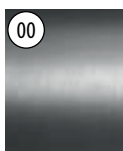

Roh



Mattsilbereffekt

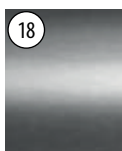

Gebürstet, anodisiert



Schwarz, matt, strukturiert

Q-INFO 316



Gebürstet



Schwarz, matt, strukturiert

Q-INFO MOD 6911

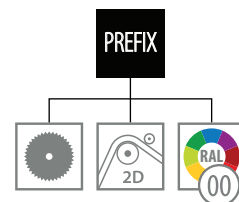

Q-INFO

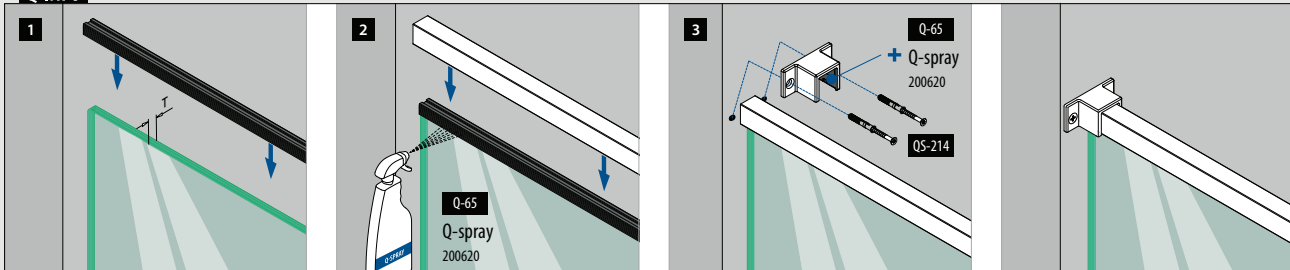



Links / rechts

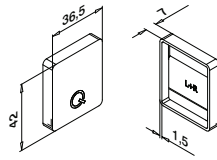

MOD 6913

Aluminium	Roh	
166913-339-00		2
Aluminium	Matt Silbereffekt	
OUTDOOR		
SELL OUT		
166913-339-08		2
Aluminium	Gebürstet	
OUTDOOR		
NEW		
166913-339-18		2
Aluminium	Black Line	
OUTDOOR		
NEW		
166913-339-82		2

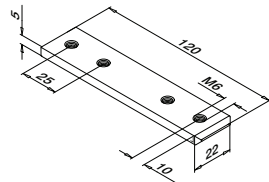

MOD 6795

Aluminium	Roh		
166795-339	QS-261	474	2

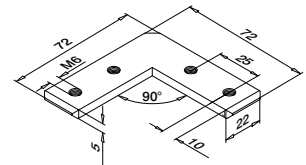

MOD 6311

Aluminium	Roh		
166311-339	QS-261	474	2

SELL OUT Nur solange der Vorrat reicht.

Q-INFO MOD 6311

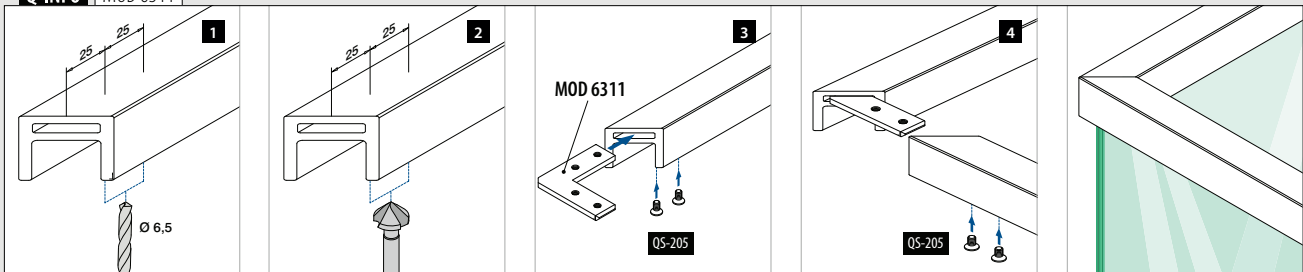



© 2023 Q-railing
Emmerich am Rhein, Deutschland

Urheberrecht / Copyright

Die Gestaltung, das Layout dieses Kataloges, Texte, Textteile, Tabellen, Bilder, Marken, Warenzeichen, Logos, Grafiken und andere Inhalte dieses Kataloges stehen entweder im Eigentum der Q-railing Europe GmbH & Co. KG, Deutschland oder werden mit Einwilligung des Eigentümers verwendet. Sie unterliegen weltweitem Urheberrecht. Soweit nicht anders angegeben sind alle in diesem Katalog verwendeten Marken und Warenzeichen sowie Kennzeichenrechte, Geschmacksmuster und Gebrauchsmuster Eigentum der Q-railing Europe GmbH & Co. KG, Deutschland oder unserer Geschäftspartner. In Deutschland und in vielen anderen Ländern ist sowohl eine strafrechtliche als auch eine zivilrechtliche Verfolgung von Verstößen gegen das Urheberrecht, Markenrecht und weiterer Schutzrechte möglich. Sollten Sie einzelne Inhalte oder komplette Seiten verwenden, kopieren, reproduzieren, im weitesten Sinne verändern, übersetzen und oder an Dritte weiterreichen oder weiterreichen wollen, so benötigen Sie unsere Einwilligung, welche wir nur schriftlich im Voraus erteilen. Fragen Sie uns also bitte vorab. Anderenfalls behalten wir uns rechtliche Schritte gegen Sie vor.



BITTE BEACHTEN

Fertigungstechnische Änderungen sowie Maßabweichungen bleiben vorbehalten. Die Originalprodukte können sich von den Fotodarstellungen geringfügig unterscheiden. Ein Reklamationsanspruch entsteht hieraus nicht. Druckfehler vorbehalten. Eine Haftung von Q-railing, gleich aus welchen Rechtsgründen, ist ausgeschlossen, sofern nicht rechtlich zwingend gehaftet wird. Hier begrenzt sich die Haftungssumme auf den reinen Warenwert des Auftrages, eine darüber hinaus gehende Haftungssumme ist ausgeschlossen. Bitte beachten Sie die gesetzlichen Vorgaben, die von Land zu Land unterschiedlich sein können. Q-railing haftet nicht für Auflagen und Bestimmungen, die für den jeweiligen Montageort Gültigkeit haben.

Es gelten unsere allgemeinen Geschäftsbedingungen. Diese finden Sie auf www.q-railing.com.





THE PREMIUM BRAND IN RAILING SYSTEMS

**Q-railing Central Europe GmbH
Niederlassung Emmerich**
Marie-Curie-Straße 8-14
46446 Emmerich am Rhein
Deutschland

T. +49 2822 915 69 0
F. +49 2822 915 69 70
WhatsApp +49 152 0865 1286
sales.de@q-railing.com

**Q-railing Central Europe GmbH
Niederlassung München**
Hanns-Schwindt-Straße 8
81829 München
Deutschland

T. +49 89 24887 460
F. +49 89 24887 469 9
WhatsApp +49 152 0865 1286
sales.de@q-railing.com



Q-RAILING CATALOGUE 2023, CE-DE • LANGUAGE DE • NO CURRENCY • 911002-011-02-00