

BILOBA

8010

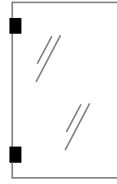
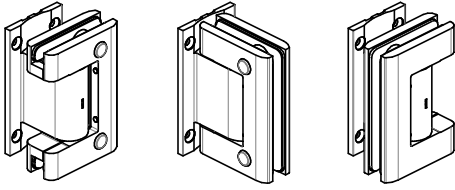

Tools Required
Strumenti Richiesti
Benötigtes Werkzeug

Fittings required
Fissaggi richiesti
Benötigtes Befestigungsmaterial

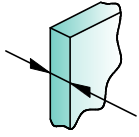
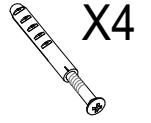
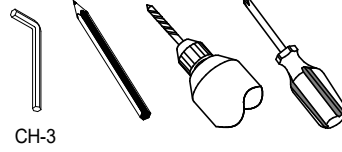

8 ÷ 13.52

GLASS
VETRO
GLAS

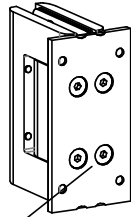

Queste viti sono serrate a 10Nm dalla fabbrica, e' vietato svitarle o allentarle



These screws are tightened at 10 Nm from the factory, it is forbidden to unscrew or loosen them

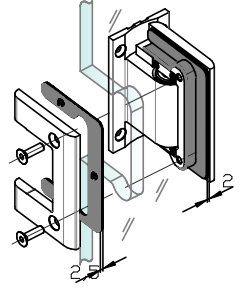
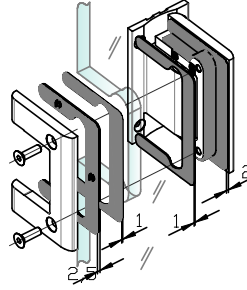

Gasket
Guarnizioni
Zwischenlagen

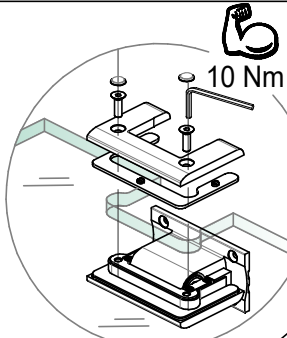
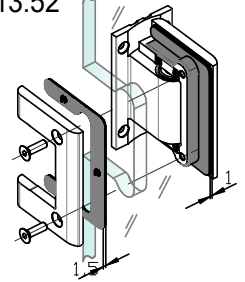
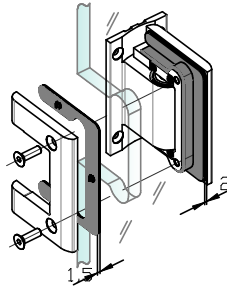

10 Nm

1

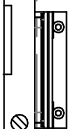
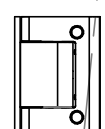
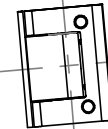
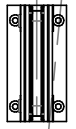
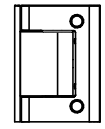
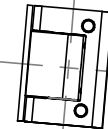
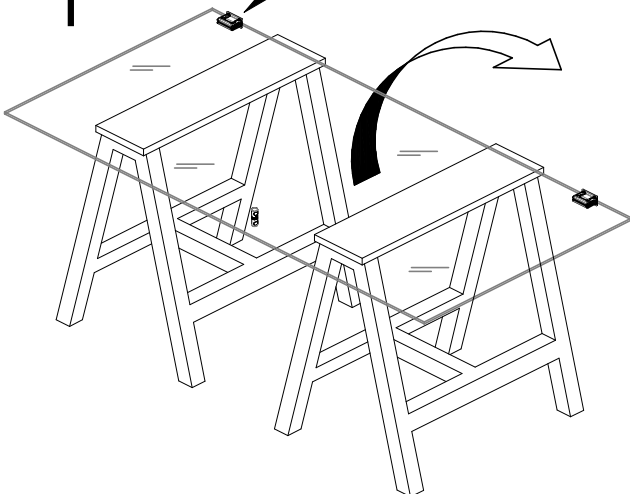

2

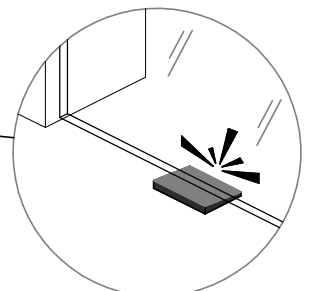

3

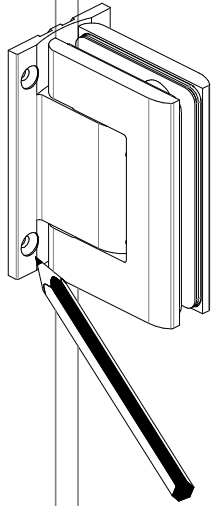

4

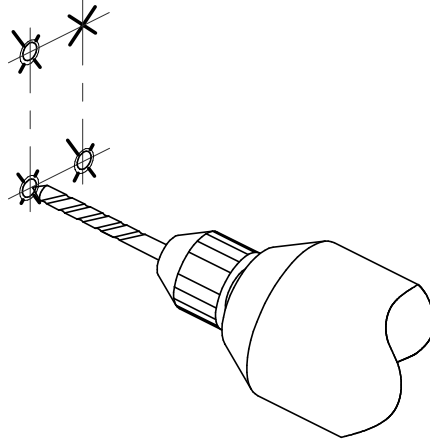

5

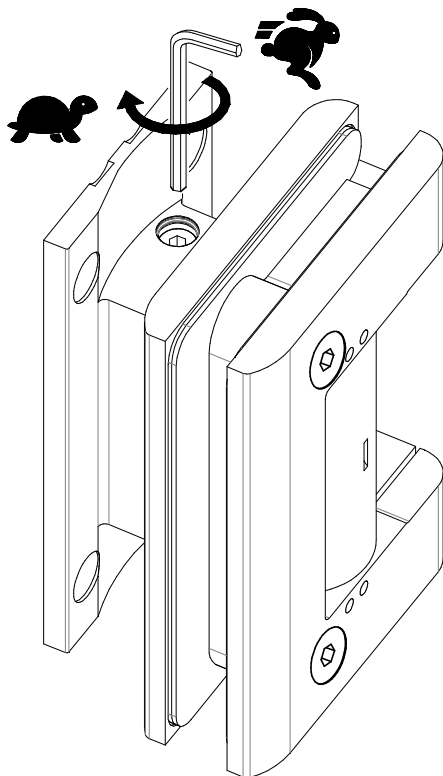
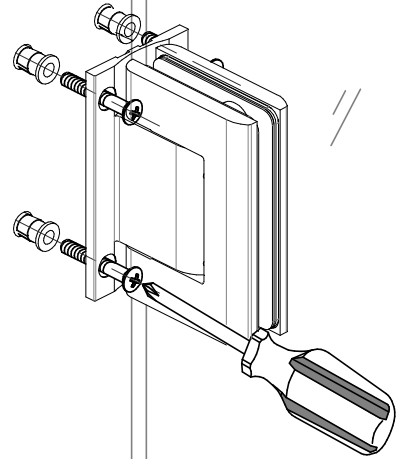

CLOSING SPEEDADJUSTING
REGOLAZIONE TEMPO DI CHIUSURA
SCHLIEßGESCHWINDIGKEITSEINSTELLUNG

Not for SOL version
Non per la versione SOL
Nicht für SOL version

