

1 Junior & Classic

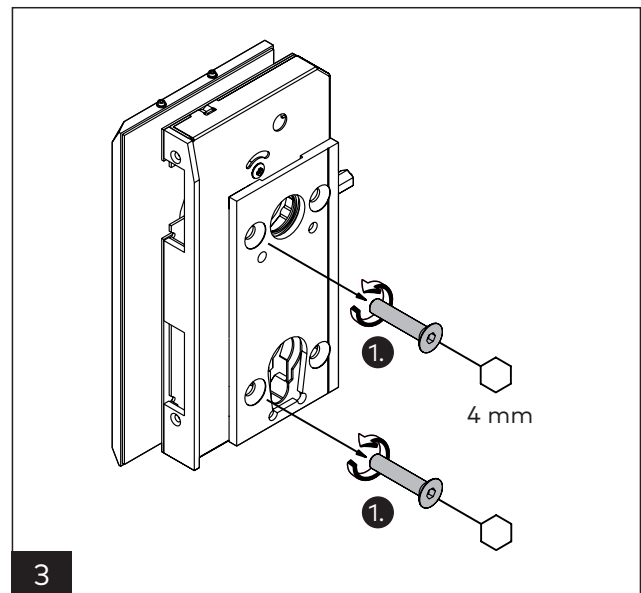
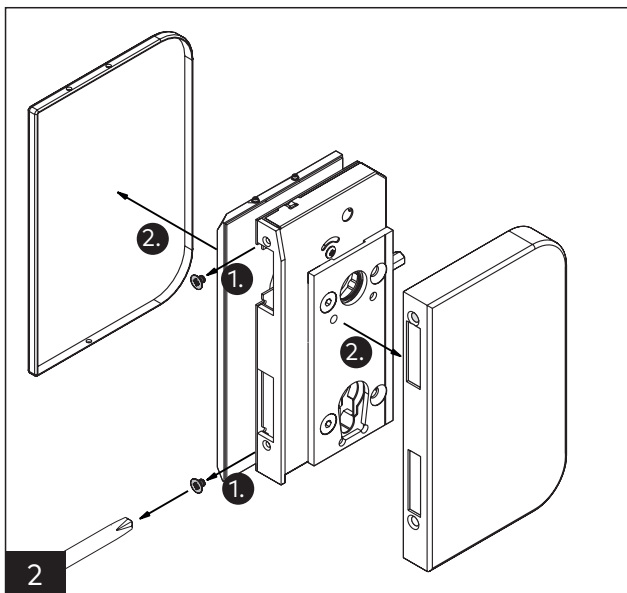
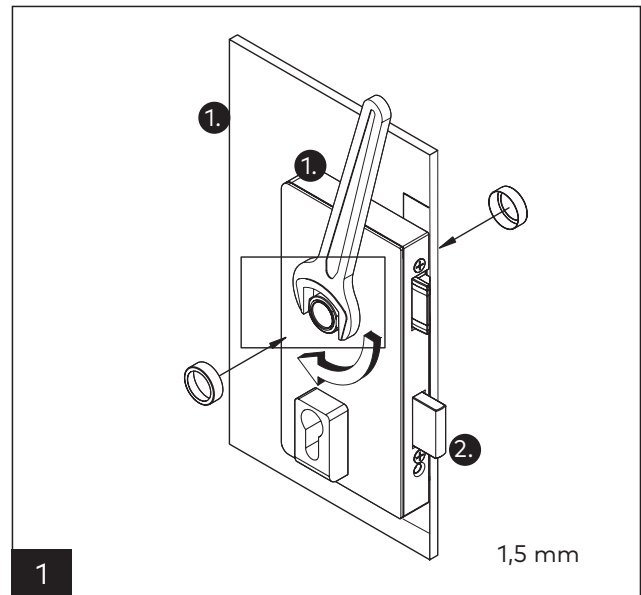
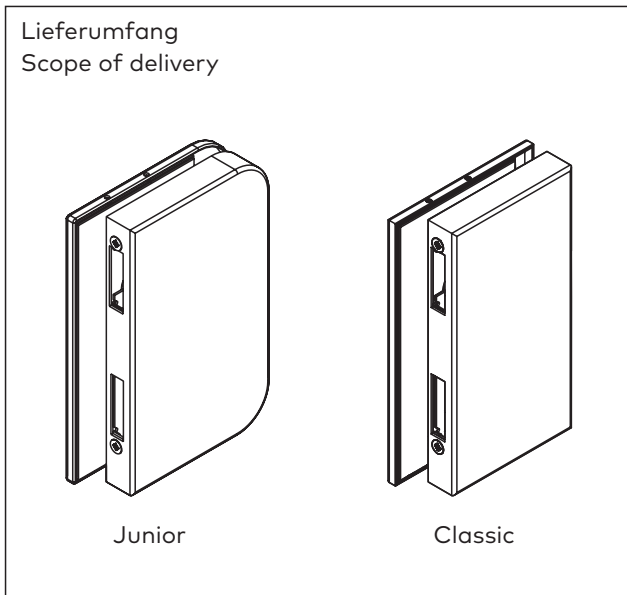

OFFICE Gegenkasten OFFICE Strike-box

Junior, Classic, Arcos & Mundus

Montageanleitung
Mounting instructions

WN 058925 45532 – 2021-03

DE | EN

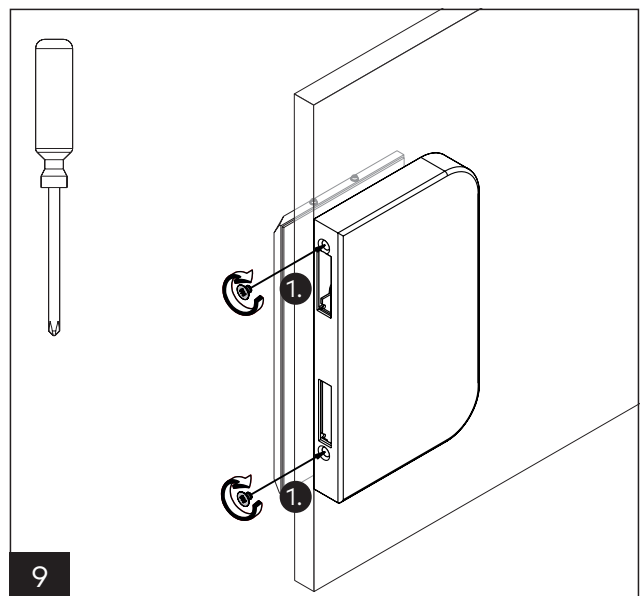
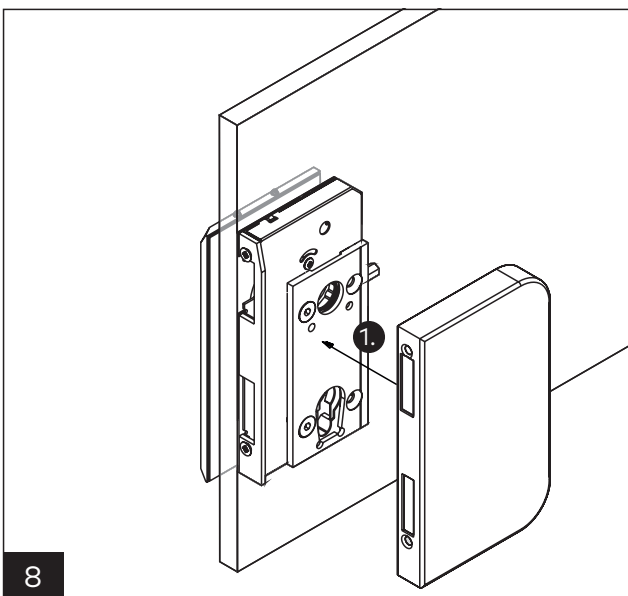
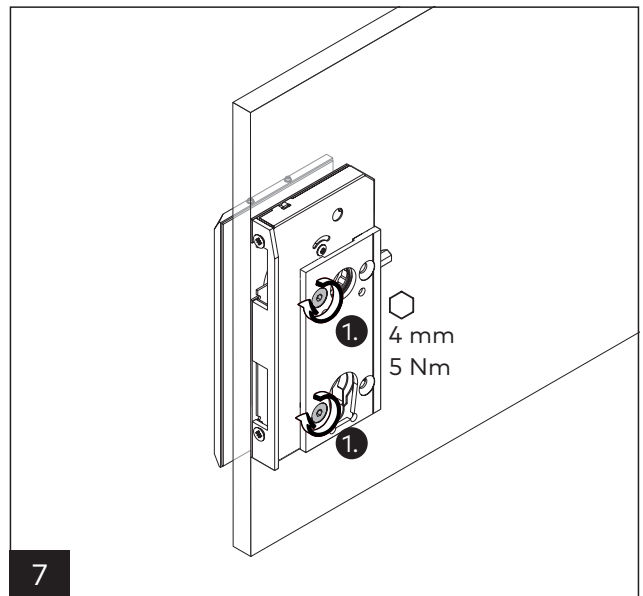
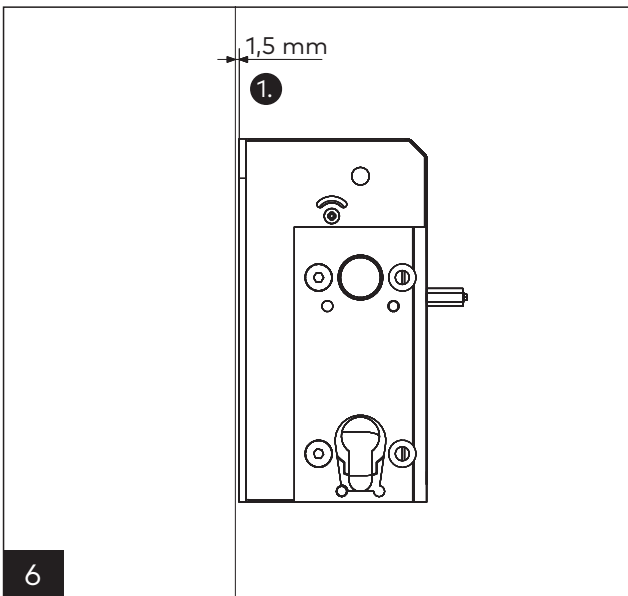
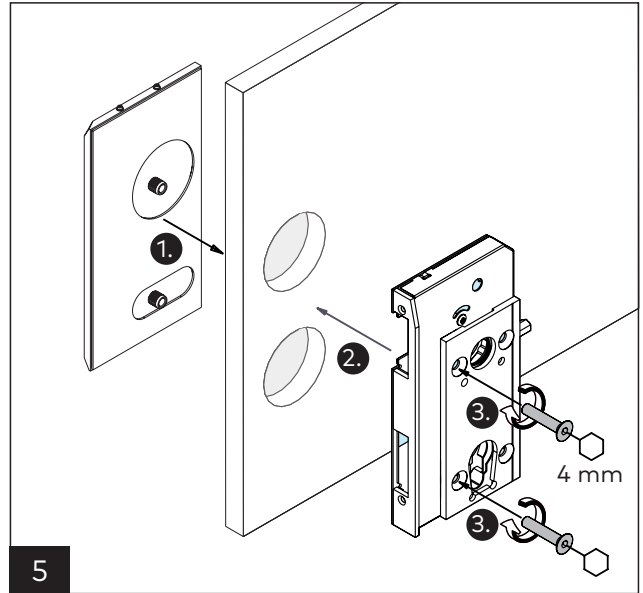
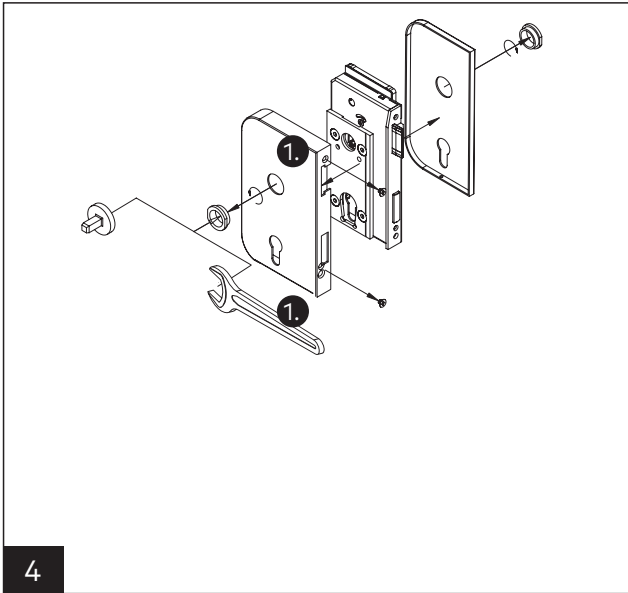

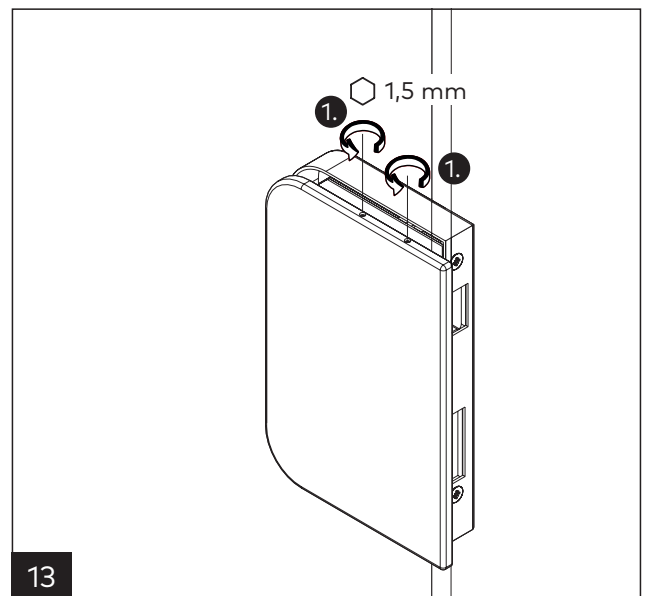
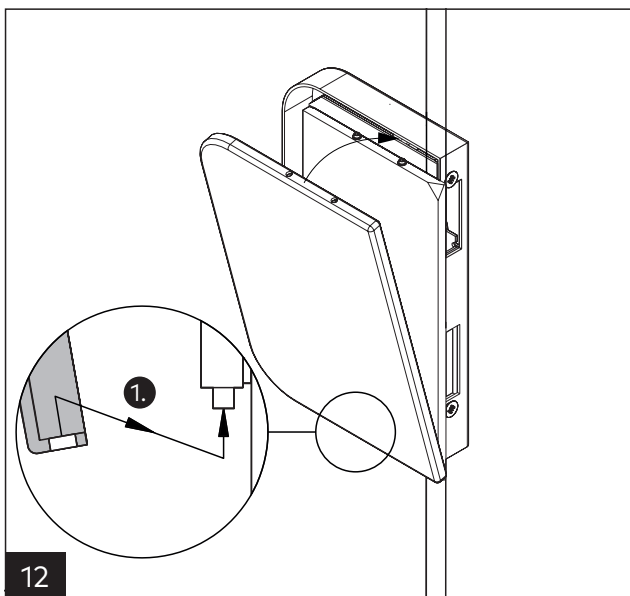
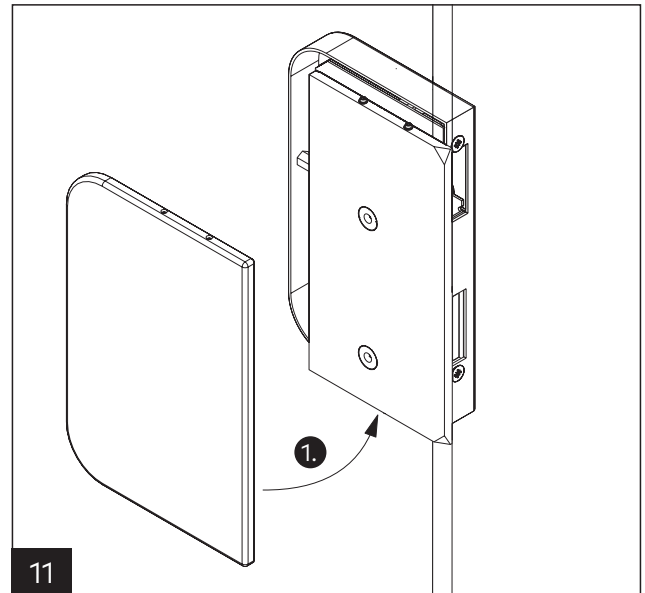
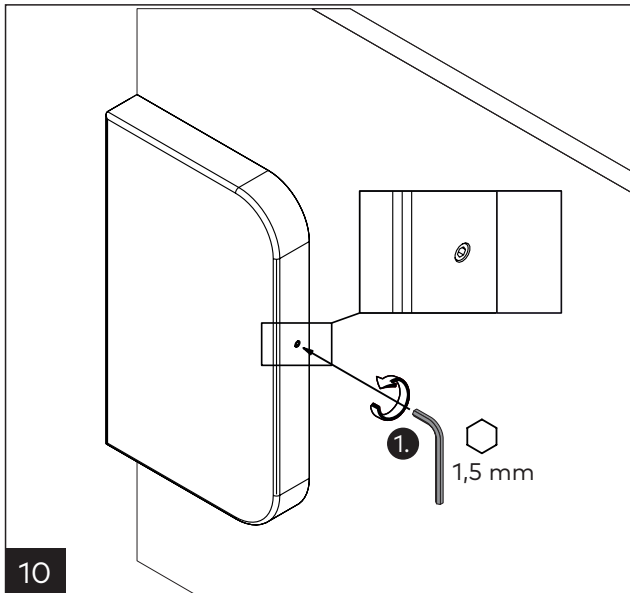

2 Mundus & Arcos

